

Universal User Guide
for
TCM-x Current Meters,
MAT-1 Data Logger
and
MAT Logger Commander Software



Lowell Instruments, LLC
82 Technology Park Dr.
East Falmouth, MA 02536
www.lowellinstruments.com
Phone: 508-444-2616
Email: support@lowellinstruments.com

Contents

Contents.....	2
1 Introduction.....	5
1.1 How to use this manual.....	5
2 Getting Started.....	6
2.1 Installing Software and USB Drivers.....	6
2.2 Connect to the Logger.....	6
2.3 Create a Setup File.....	7
2.4 Save File on MAT-1 Logger drive.....	8
2.5 Communicating with the Logger.....	9
2.6 Check the Logger’s Status, Set the Clock and View Real-Time Orientation.....	11
2.7 Start the Logger.....	13
2.8 Demo Deployment.....	13
2.9 Stop Logging and Saving Data.....	14
2.10 Convert Data.....	15
2.11 View Data.....	16
3 TCM Current Meters.....	17
3.1 Theory of Operation.....	17
3.2 TCM Logger Settings.....	18
3.3 Assembling the Current Meter (TCM-1 Only).....	19
3.4 Selecting a Velocity Range (TCM-1 Only).....	19
3.5 Anchoring Guidelines.....	20
3.6 Other Deployment Considerations.....	22
3.7 Data Retrieval and Conversion.....	22
4 Logging Modes & Setup File.....	23
4.1 Deployment Description.....	25
4.2 Operational Indicator Control.....	25
4.3 Enabling and Disabling Logging Channels.....	26
4.4 Recording Rate & Burst Mode.....	26
4.5 Start and Stop Times.....	27
5 Logger Status.....	28

5.1	Port Control	28
5.2	Logger Control	29
5.3	Status	29
5.4	Sensor Data	29
5.5	Logger Information	29
6	Convert Files	30
6.1	Output Type	31
6.1.1	XYZ	31
6.1.2	Yaw/Pitch/Roll	31
6.1.3	Heading	32
6.1.4	Current (Tilt Current Meter)	33
6.2	Time Format	34
6.3	Split Data Files During Conversion	34
6.4	Calibration Coefficients	34
7	Sensor Information	35
7.1	Sensor Orientation	35
7.2	Magnetometer	35
7.3	Accelerometer	36
7.4	Thermistor	36
8	Logger Maintenance	36
8.1	O-Ring Care	36
8.2	Logger Housing Care	37
8.3	SD Card	38
8.3.1	Ejecting the Card	38
8.3.2	Reformatting the SD Card	38
8.3.3	Card Type	38
8.4	Battery Information	39
8.4.1	Battery Life	40
8.4.2	Safe Shutdown	40
8.4.3	Replacing the Battery & Desiccant	41
9	Trouble-Shooting the Logger and Software	42
9.1	Firmware Updates	44

9.2	Serial Number.....	44
9.3	Repair Policy.....	44
9.4	Returning Products to Lowell Instruments	44
9.4.1	Return Shipping Address	44
10	Additional Information.....	45
10.1	Optional Accessories.....	45
10.2	Contact Information.....	45
10.3	Disclaimer.....	45

1 Introduction

Congratulations on your purchase of a TCM-x or MAT-1 from Lowell Instruments! We hope that your new device serves you well for many years. We have attempted to include the “right amount” or detail in this guide: not too much, not too little. But we also know that, even after a thorough reading, some things may not be clear. Please feel free to [contact us](#) if you have questions.

1.1 How to use this manual

This user guide is intended for users of both the MAT-1 Data Logger and the TCM-x Current Meters. The TCM-x Current Meters use a MAT-1 Data Logger as the “brains” of the meter and the material substantially overlaps.

Both MAT-1 and TCM-x users should read Section 2 “[Getting Started](#)”. This section describes basic operation of the hardware and software. Users of the TCMs will also want to read Section 3 “[TCM Current Meter](#)” for instructions that are specific to operating current meters.

2 Getting Started

2.1 Installing Software

The MAT-1 Data Logger requires that *MAT Logger Commander Software* be installed to operate the logger. It is highly recommended that you install the software prior to connecting the logger to a USB port. Go to www.lowellinstruments.com/Downloads to get the latest version of MAT Logger Commander and follow the software installation instructions.

2.2 Connect to the Logger

Remove the end cap of the logger by unscrewing it. Connect the USB cable to your computer and connect the other end of the cable to the logger. Windows should automatically find the logger and connect to it. (See “Troubleshooting” if Windows does not succeed in loading the drivers automatically.)



This end is permanently sealed.
Do not attempt to open.

Unscrew this end.

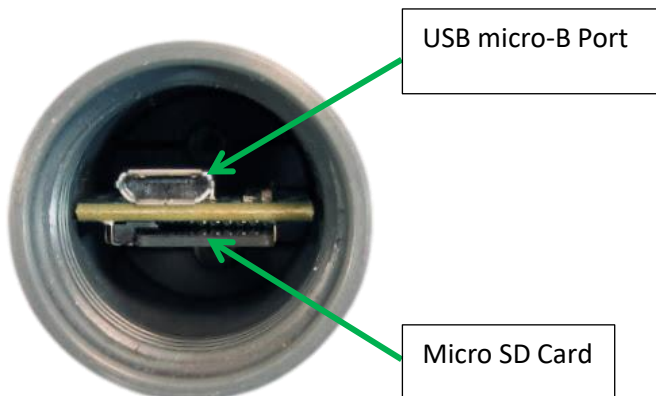

Caution: The logger will be damaged if water enters the housing. Keep the O-ring clean and free from dust, hair and dirt. See “O-ring Care” for more information.

Tip: The USB cable used with the MAT-1 logger is the same type of cable that is commonly used by many Android smart phones. If you lose your cable you can purchase a replacement at many stores.

2.3 Create a Setup File

The logger uses a setup file to operate. The setup file is stored on the SD card and contains the settings that the logger will use when it is instructed to start logging: enabled/disabled channels, recording intervals, start and stop times etc.

See "[Typical Current Meter Settings](#)" for specific instructions on creating a setup file for use with a tilt current meter.

Open MAT Logger Commander and select the "Setup File" icon to open the Setup File screen. You will use this screen to create a setup file. Start by entering a description and choose your logging parameters. If this is your first test, keep it simple. Follow the example below:

1. Setup File Tab

2. Logging Parameters

3. Save File

Tip: The description is limited to 15 characters and may only contain alpha-numeric characters, dashes, underscores and spaces. The description will become part of the data file name when the deployment is complete.

2.4 Save File on MAT-1 Logger drive

Click “Save Setup File...,” and navigate to your logger’s USB drive. If you are using a SD card supplied by Lowell Instruments, the drive will be labeled “MAT_LOGGER”. It is essential that the setup file be named “MAT.cfg” and be saved on the logger’s SD card. The logger will look for this file when you instruct the logger to start recording data (in the next step) and it will load the values that you saved in the file. The logger will not start if the MAT.cfg file is missing.

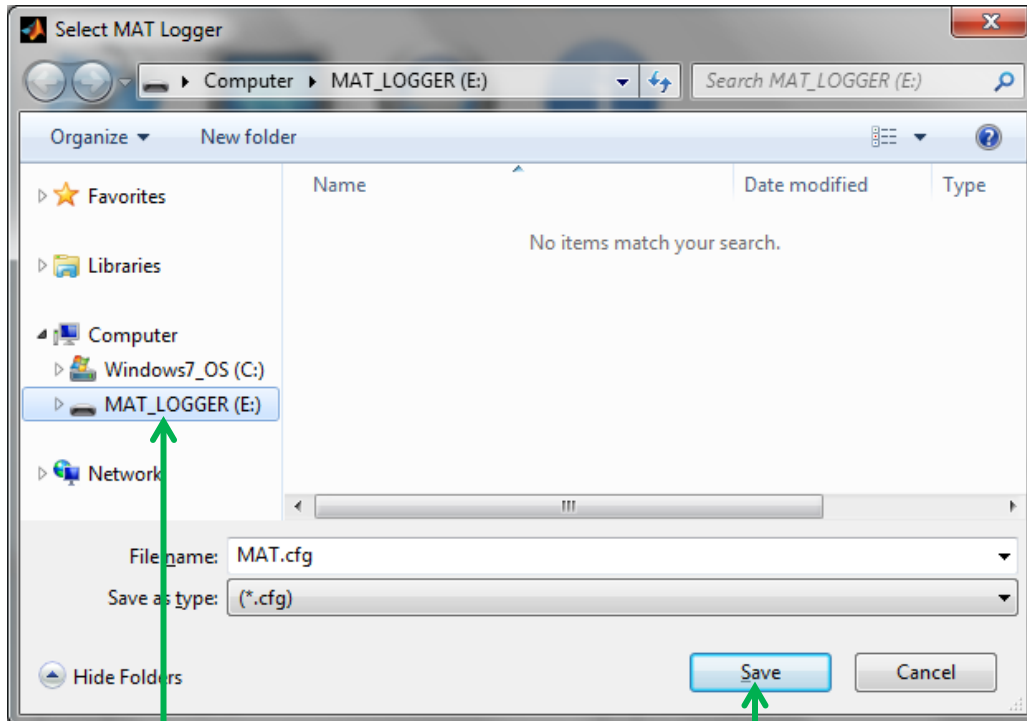

1. MAT Logger Drive

2. Save File

Tip: If you have multiple loggers that you want to configure in the same way, it may be convenient to save this file on your hard drive and copy it with Windows Explorer to the other SD cards.

2.5 Communicating with the Logger

Select the “Logger Status” icon and then click “Find Logger.” The software will check for a connected logger and get current readings from the logger.

1. Select “Logger Status”

2. Click “Find Logger”

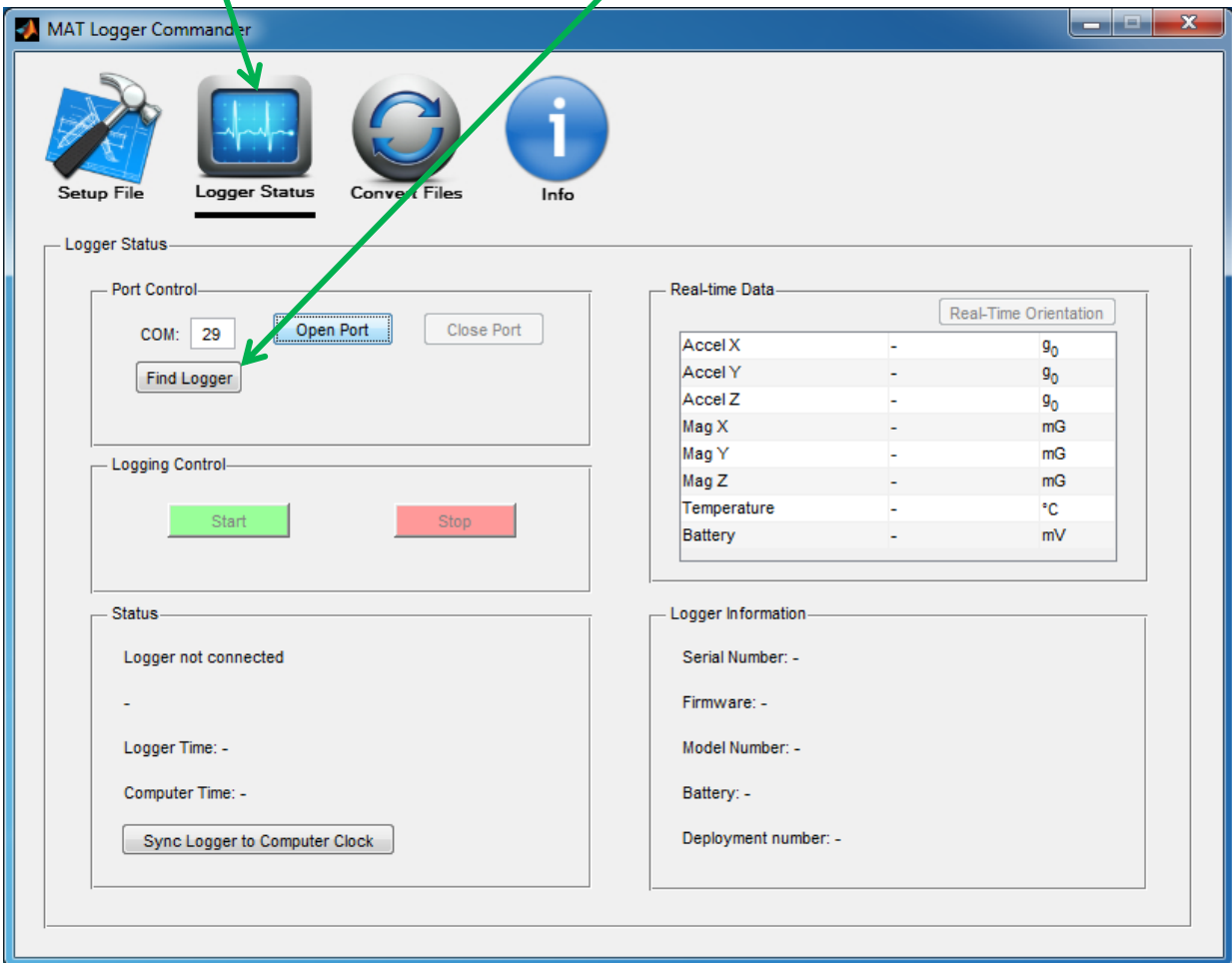

Tip: Windows assigns a unique COM port number for each physical port on your computer. When you connect your logger to a different USB port, Windows will assign a new COM port number, and you will need to re-scan the computer to determine the new COM port number. If you already know the COM port number, enter it manually. This will skip the search for all available ports and will save time.

When the logger connects this first time it will be stopped. The status will be in red and will indicate “Stopped.”

Logger is not collecting data.

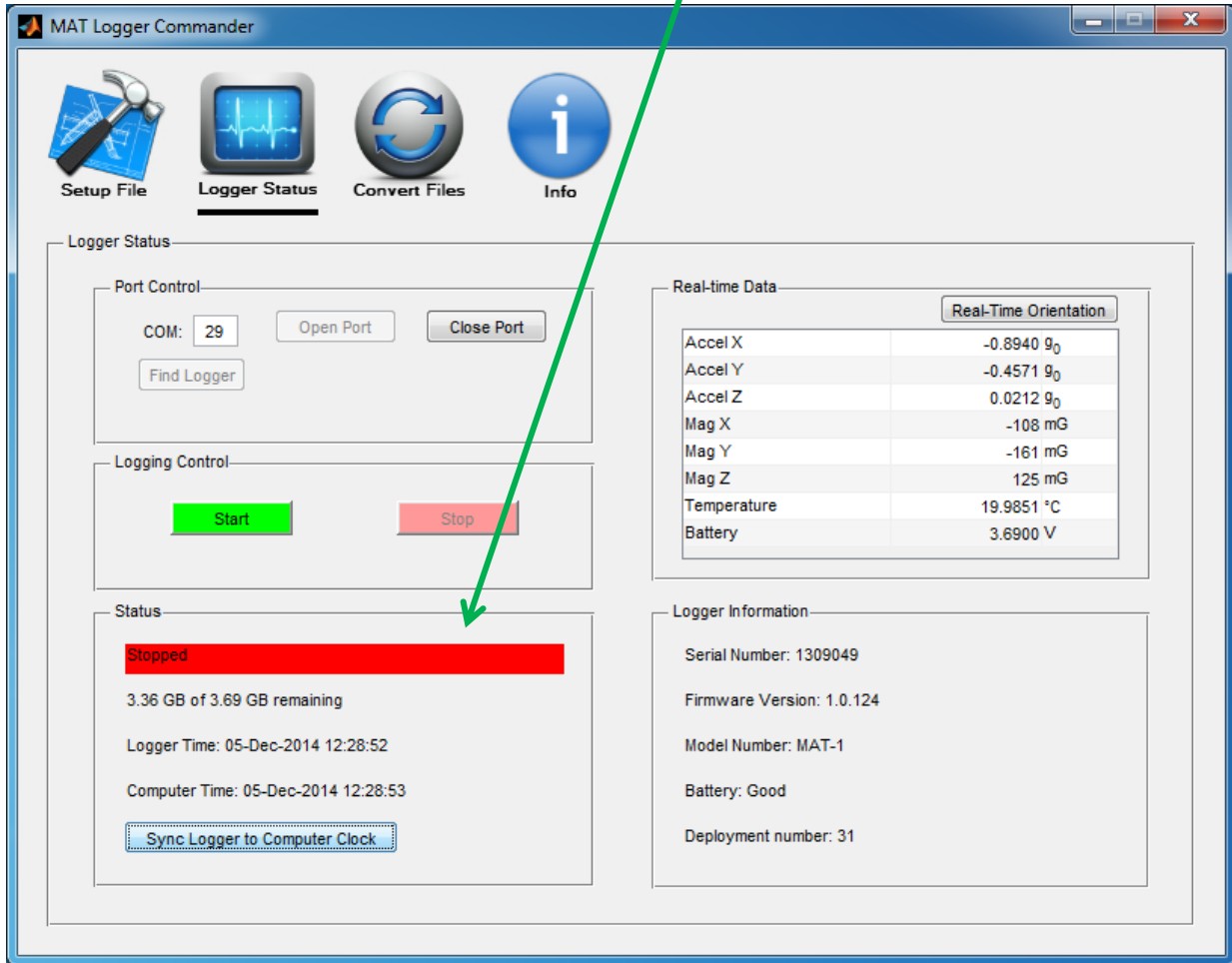

2.6 Check the Logger's Status, Set the Clock and View Real-Time Orientation

The software should now be connected to the logger and will display sensor readings and logger information. Follow these steps to start the logger:

1. Set the logger's clock by synchronizing it to the computer's clock.
2. Check the sensor readings for current readings.
3. Click "Real-Time Orientation" to animate the logger's orientation.

2. Check Sensor Data and Logger Information

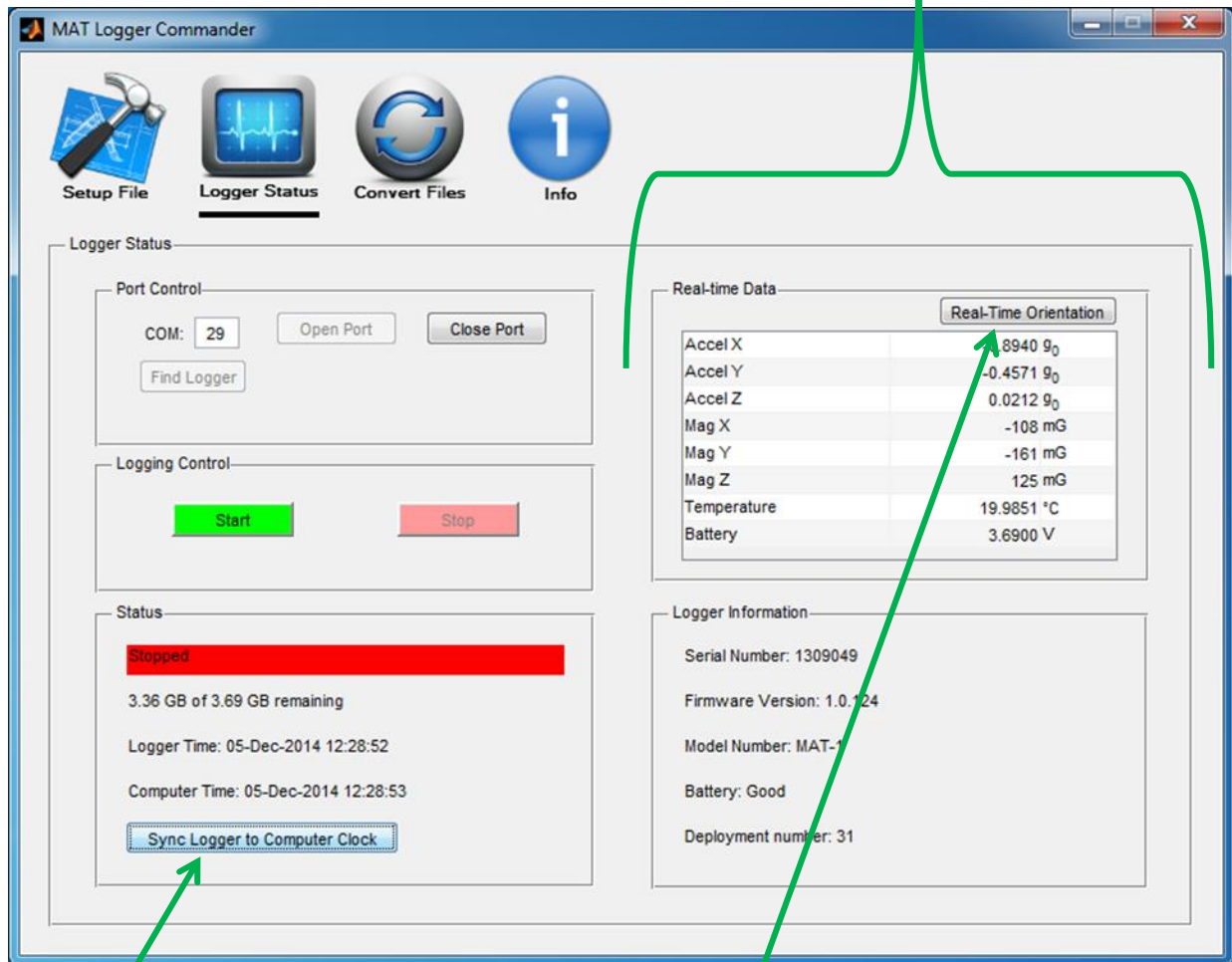

1. Click to Set Clock

3. Click to view Real-Time Orientation

4. The logger will show its orientation with respect to gravity and magnetic north. To reorient with respect to your perspective, click the “Reorient” button. This will not permanently change the sensor orientation.
5. Click “Close” when done.

5. Click to exit real-time orientation mode.

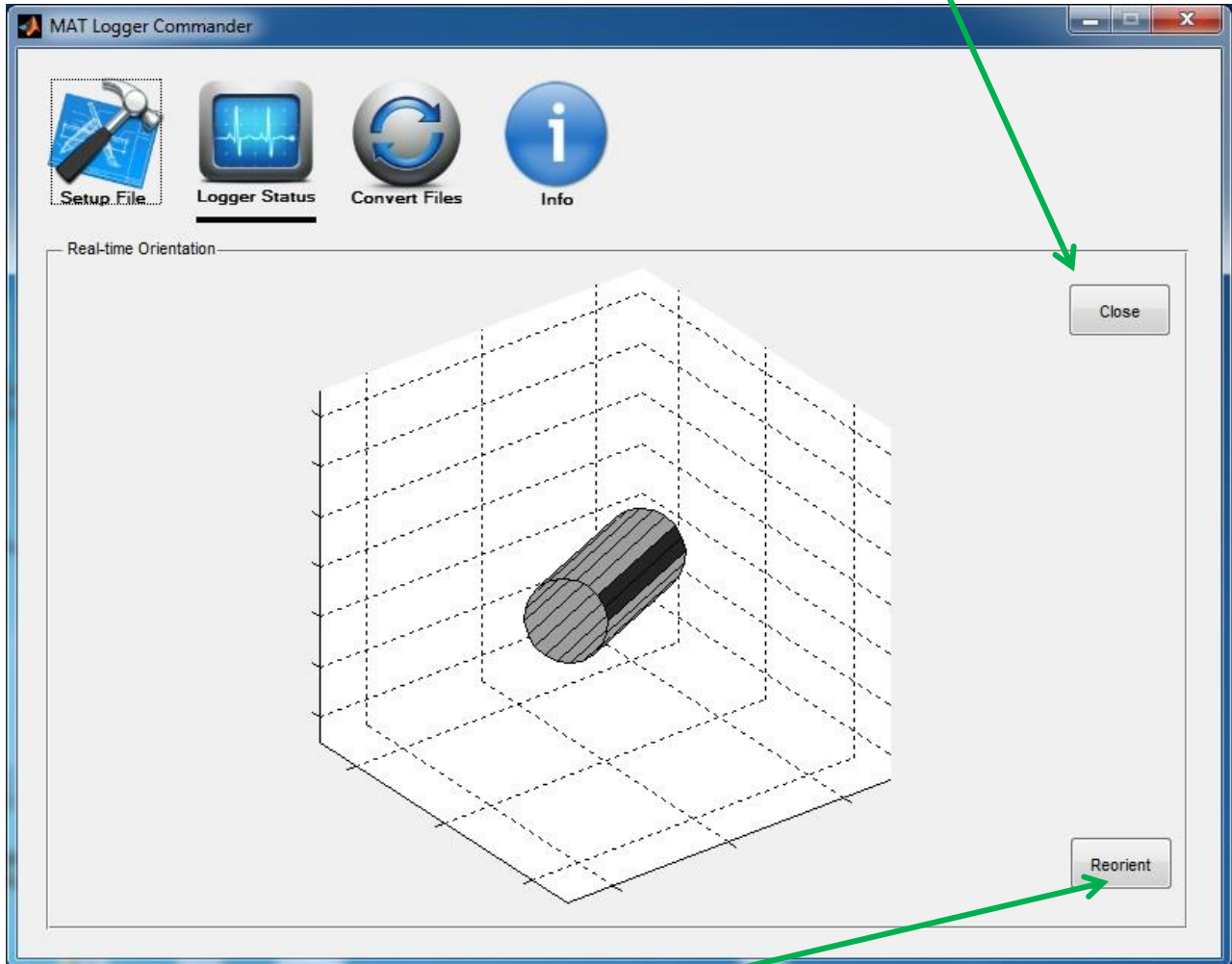

4. Click to change perspective.

2.7 Start the Logger

Click “Start Logging” to command the logger to start recording measurements. The logger will pause for a moment and then start to record data according to the settings that were saved in the setup file on the microSD card. Wait for the status to change from Stopped (in red) to Running (in green). The MAT_LOGGER drive will close automatically.

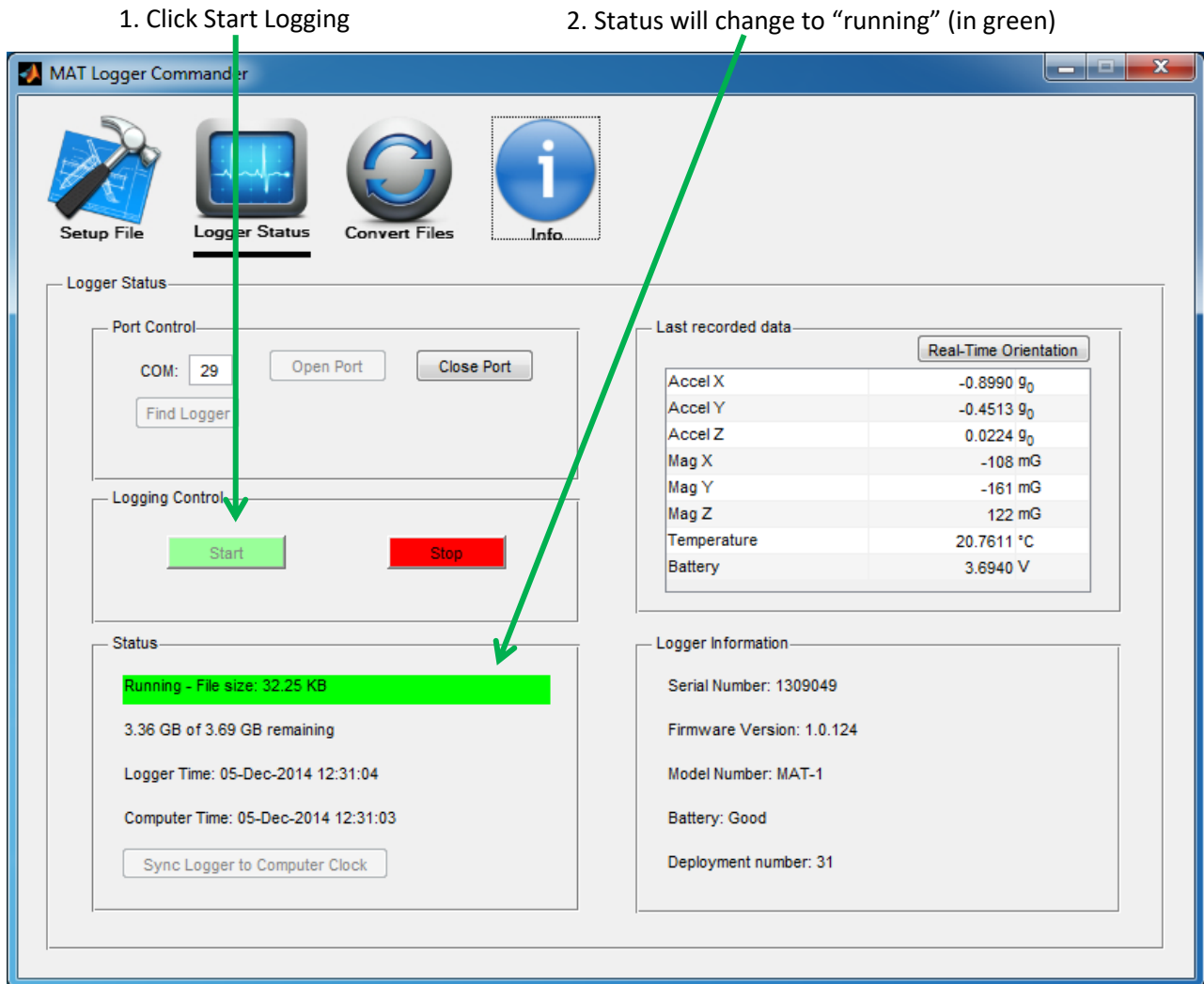

Tip: Check that your computer’s clock is accurate by navigating to www.time.gov. If it is off by more than a few seconds, check that your computer is being automatically updated by a NIST time server.

2.8 Demo Deployment

The logger is now collecting data. You can disconnect the USB cable, replace the cap, and deploy it. For a simple demo, slowly roll the logger across a flat surface or swing it with your arm.

2.9 Stop Logging and Saving Data

Reconnect the USB cable and reconnect to the logger by clicking “Open Port” from the Logger Status screen. Wait for the software to connect and then click “Stop Logging.” Navigate to the MAT_LOGGER drive in Windows Explorer. The file name will have the serial number pre-pended to the description. Copy the data file to a working folder on your computer.

Tip: There are two reasons to copy your data file to a working folder rather than leaving it on the SD card. The first is that by copying the data you have a backup copy, reducing the chance of loss. The second is that the next step, “Converting Data,” will be much faster if you are working from a hard drive rather than relying on the MAT-1 logger’s relatively low-speed USB connection.

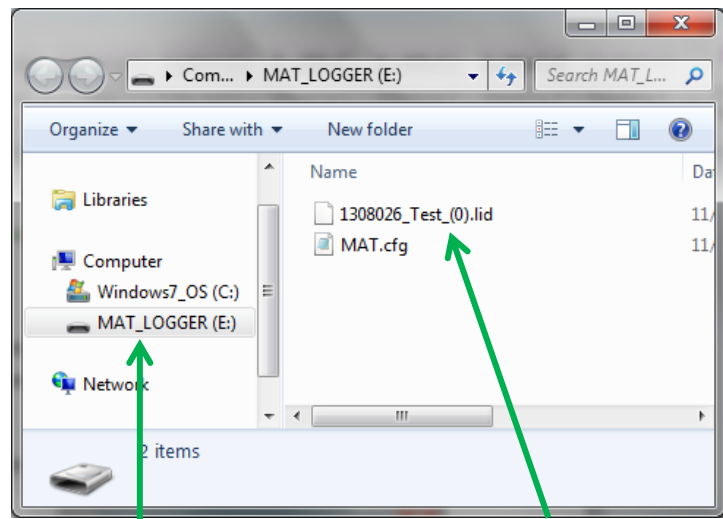

1. Select Drive

2. Copy File to Local Drive

2.10 Convert Data

The MAT-1 logger stores data in a binary format that cannot be directly used by third-party tools; it must be converted to text first. Switch to the “Convert Files” screen. There are several format options but for this test simply click on “Convert File” and select the data file that you saved in your working folder.

1. Select “Convert Files”

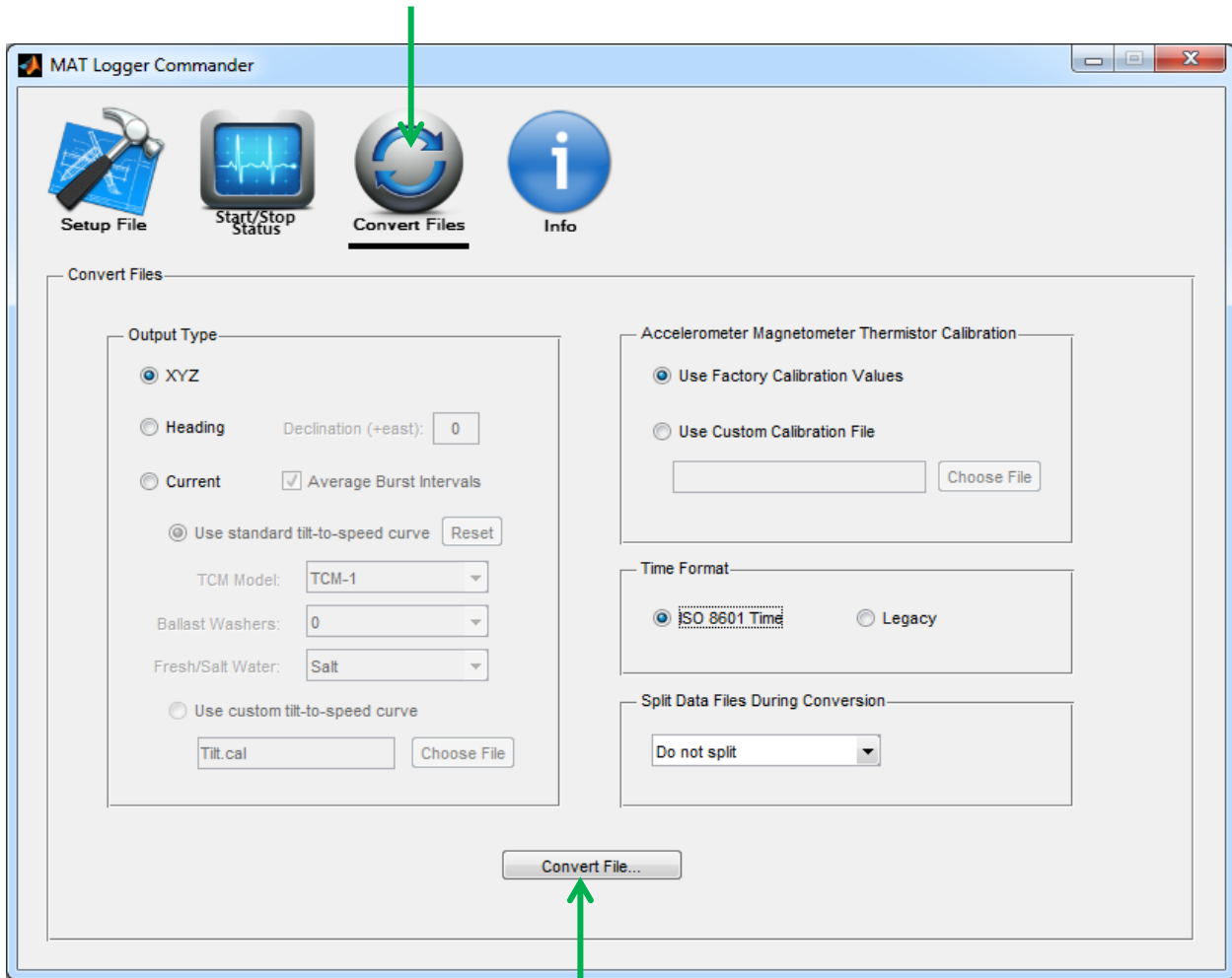

2. Click “Convert File”

Tip: The XYZ output text files will be substantially larger than the binary file. Large files may be difficult or impossible to open with some applications. In the future, if you have a large file, you may want to use the option to split the file during data conversion.

Tip: You may convert the same file as many times as you like in different formats (XYZ, Roll/Pitch/Yaw). The binary file will be preserved during the conversion.

2.11 View Data

MAT Logger Commander will convert the binary file into two text files that can be easily opened with a spreadsheet or other application. The files are saved in the same directory as the binary file. One file will contain the magnetometer and accelerometer data and the other will contain the temperature data. The text file can be opened by a variety of applications.

Tip: Always save a copy of the binary file. It is tempting to delete the binary file once the conversion is complete but it is not a good idea. The binary file contains information about the deployment that is not copied to the text file. In the event of a problem, the binary file is an essential for debugging and backup.

The file with the magnetometer and acceleration data should look something like this:

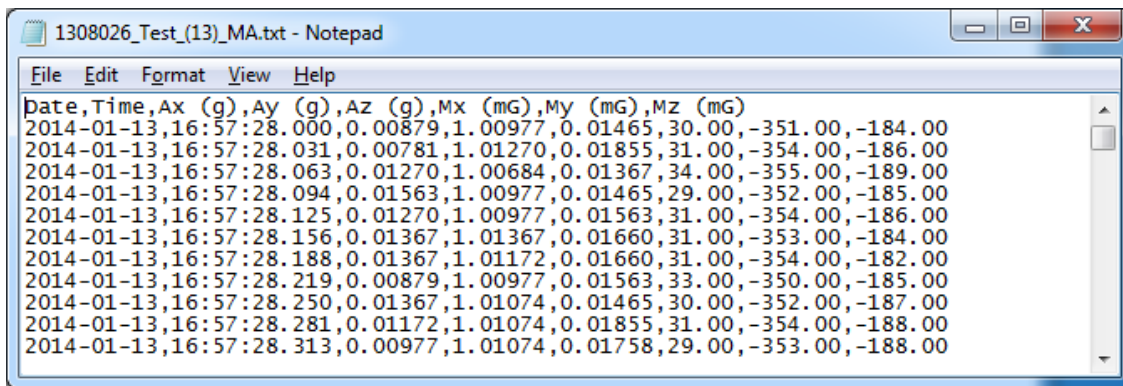

```
1308026_Test_(13)_MA.txt - Notepad
File Edit Format View Help
Date,Time,Ax (g),Ay (g),Az (g),Mx (mG),My (mG),Mz (mG)
2014-01-13,16:57:28.000,0.00879,1.00977,0.01465,30.00,-351.00,-184.00
2014-01-13,16:57:28.031,0.00781,1.01270,0.01855,31.00,-354.00,-186.00
2014-01-13,16:57:28.063,0.01270,1.00684,0.01367,34.00,-355.00,-189.00
2014-01-13,16:57:28.094,0.01563,1.00977,0.01465,29.00,-352.00,-185.00
2014-01-13,16:57:28.125,0.01270,1.00977,0.01563,31.00,-354.00,-186.00
2014-01-13,16:57:28.156,0.01367,1.01367,0.01660,31.00,-353.00,-184.00
2014-01-13,16:57:28.188,0.01367,1.01172,0.01660,31.00,-354.00,-182.00
2014-01-13,16:57:28.219,0.00879,1.00977,0.01563,33.00,-350.00,-185.00
2014-01-13,16:57:28.250,0.01367,1.01074,0.01465,30.00,-352.00,-187.00
2014-01-13,16:57:28.281,0.01172,1.01074,0.01855,31.00,-354.00,-188.00
2014-01-13,16:57:28.313,0.00977,1.01074,0.01758,29.00,-353.00,-188.00
```

If you plot the data with your favorite plotting software, it might look like this:

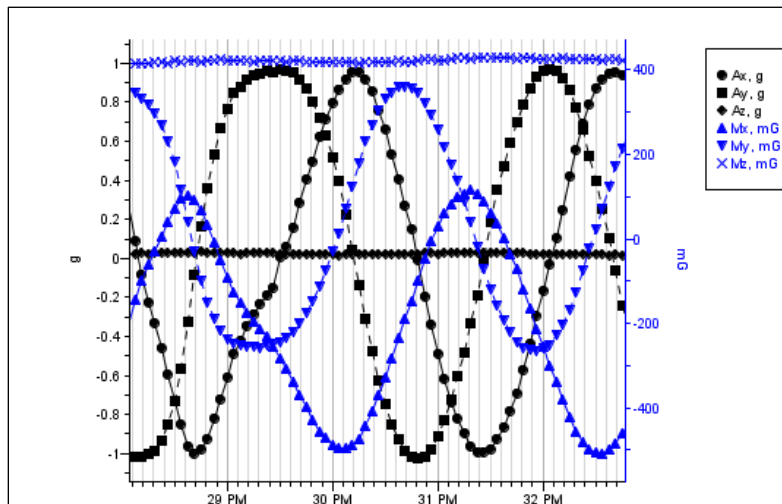

If you made it this far, congratulations, you know the basics. This concludes the “Getting Started” section. The remaining sections of this guide contain additional detail about the logger and software.

3 TCM Tilt Current Meters

(The following section applies only to TCM Current Meters. Users of the MAT-1 Data Logger for non-current related measurements may want to skip this section.)

3.1 Theory of Operation

All TCM-x meters measure current using the drag-tilt principle. Typically, the logger is buoyant and is anchored to the bottom via a short flexible tether. Drag from moving water tilts the logger in the direction of flow. The MAT-1 data logger's accelerometer and magnetometer channels are used to record the amount of tilt and direction of tilt (compass bearing).

Ideally, for constant water velocity, the buoyancy, drag, gravity and anchor line tension are all in balance and the tilt angle and direction are static. In practice, even in ideal conditions, the position of the meter is not static. [Vortex shedding](#) induces oscillation in the TCM. Vortex shedding is normal and is factored into the calibration of the meter but it must be filtered out. In the field turbulence and waves add additional motion. Fortunately, oscillations are relatively easy to filter out by taking multiple measurements and determining the average tilt and bearing.

The frequency over time of vortex shedding varies with water speed and model number but is in the range of 0.5 to 2 Hz. To avoid [aliasing](#), the meter should be configured to sample at least two complete oscillations: a minimum of 4 samples per second for at least 4 seconds but we normally record a minimum of 8 Hz for 10 seconds. (Additional consideration should be made for waves, turbulence and improved accuracy.)

MAT Logger Commander Software will be used to configure the logger to record in "Burst Mode" prior to deployment and it will be used again after the deployment to post process the data file and calculate the average speed and direction per interval.

3.2 Typical Tilt Current Meter Settings

The “brains” of the tilt current meter is the MAT-1 data logger. The MAT-1 has the ability to use a “burst mode” recording interval (see Figure 1). This note highlights the three “burst mode” parameters that are stored in the MAT.cfg file and are used to configure the TCM for a range of environments.

Burst Logging sets the logger to alternate between rapid sampling and sleep mode. Burst Logging allows for accurate measurements while conserving battery life. For example, a typical configuration would have the meter wake up every minute, record at 8 Hz for 15 seconds and then sleep for 45 seconds. The result of this setup would be 120 samples recorded every minute. After the deployment is complete, the 120 samples will be post processed into 1 minute velocity records. Thus, in this example, each velocity measurement is an average of 120 samples taken over a 15 second period.

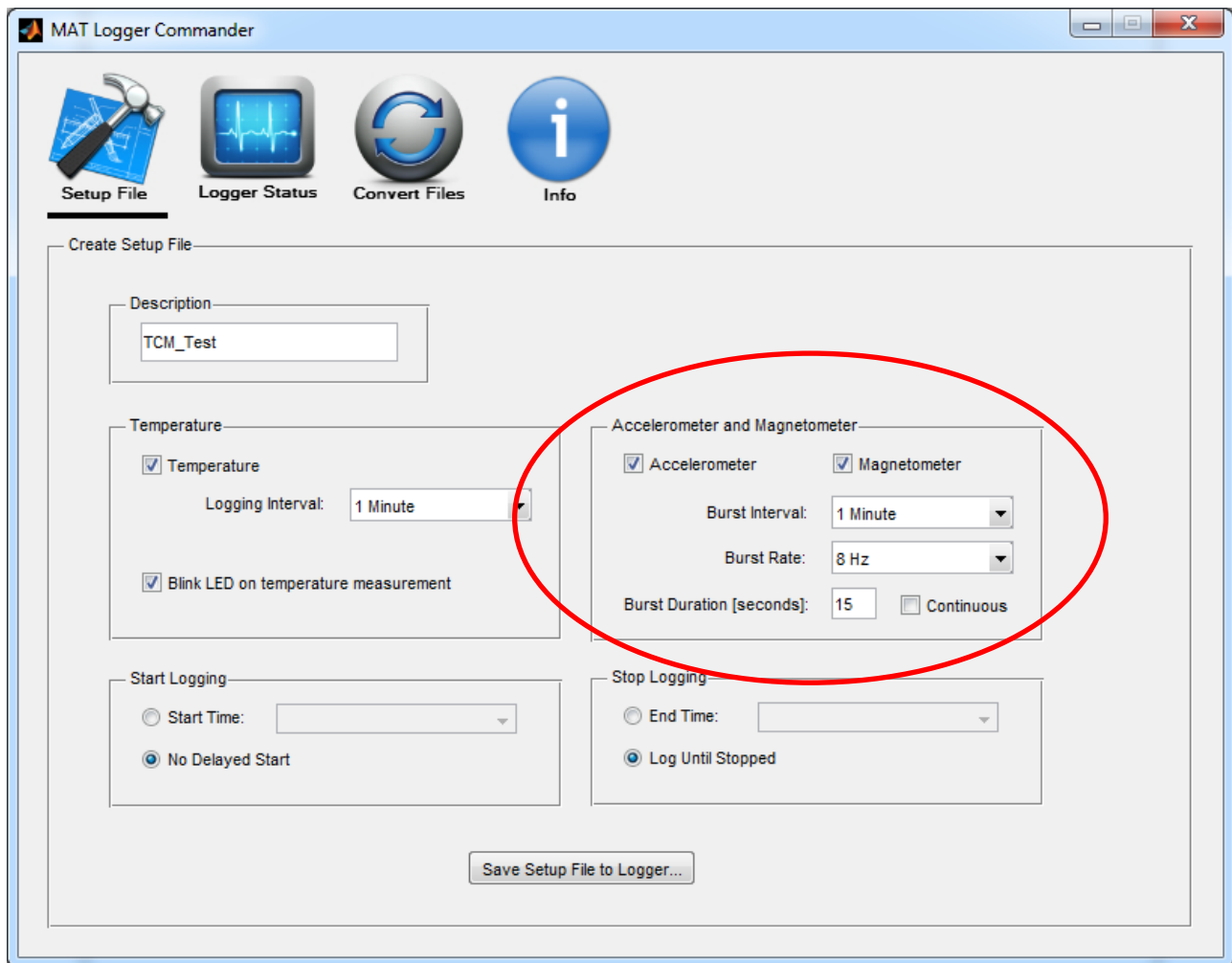

Figure 1: Typical settings for a TCM deployment. The burst mode parameters are circled.

Burst Interval: This parameter sets the measurement interval. Each current measurement is comprised of a series (or a “burst”) of measurements. The Burst Interval is the length of time between the start of

any two intervals. Typically, the Burst Interval is set between 1 and 5 minutes, providing high temporal resolution data that can be post-processed into longer intervals if desired.

Burst Rate: This parameter sets the rate at which samples are recorded during the “burst”. Even in ideal conditions, the meter oscillates with a period of 2-4 seconds. Thus, to record the average tilt and bearing more than one measurement is required. The minimum recommended burst rate is 4 Hz, with 8 Hz typical. 16 Hz is recommended for more energetic environments with waves.

Burst Duration: This parameter sets the length of time that the accelerometer and magnetometer sample at the burst rate. To obtain an accurate average, the burst duration should be at least twice the period of any oscillation in the system. As previously mentioned, the TCM oscillates with a period of 2-4 seconds. The recommended minimum burst duration is 10 seconds, with 15 seconds more typical. If there is a dominant swell, the burst duration should be increased to 30-60 seconds depending on the swell period.

Temperature: Enable the temperature channel for reference and for temperature compensation of the magnetometer.

Note that all three of these settings impact battery life. The MAT-1 will run for many months with typical settings before battery failure (memory is never the limiting factor). However, running continuously at the maximum rate will reduce the battery life to as little as 6 weeks. Three sets of recommended settings are shown in the table 1 below.

Table 1: Recommended settings for TCM-1 deployments in three typical environments.

Configuration	Temperature	Burst Interval (s)	Burst Rate (Hz)	Burst Duration (s)	Notes
Typical	1 min.	60	8	15	Suitable for most environments with limited swells. Battery life: 12-14 months
Swells	2 min.	120	8	45	Increased burst duration for filtering long-period swells. Battery life 10-12 months.
Waves & Turbulence	1 min.	60	16	30	Increased burst rate and duration for filtering moderate swells and wave induced turbulence. Battery life 5-6 months.

3.3 Anchoring Guidelines

Tilt current meters are sensitive to how they are anchored. For best results follow these guidelines.

1. Typical anchors include:
 - 12 or 18-inch square concrete patio stones (30 x 30 x 5 cm or 45 x 45 x 5 cm)
 - Cinder block

- Lead disk weights
 - Dive belt weights
2. Avoid anchors made from large amounts of steel or iron; they will create soft and/or hard iron errors in the compass bearing.
 3. Set the lanyard length to 1/2 to 1" (13-25 mm) between the anchor and the TCM-1.
 4. The ideal anchor will have a 5/16" (8mm) hole through which the lanyard can be passed and knotted on the back side. This will ensure that the lanyard length is constant and symmetric regardless of current direction.

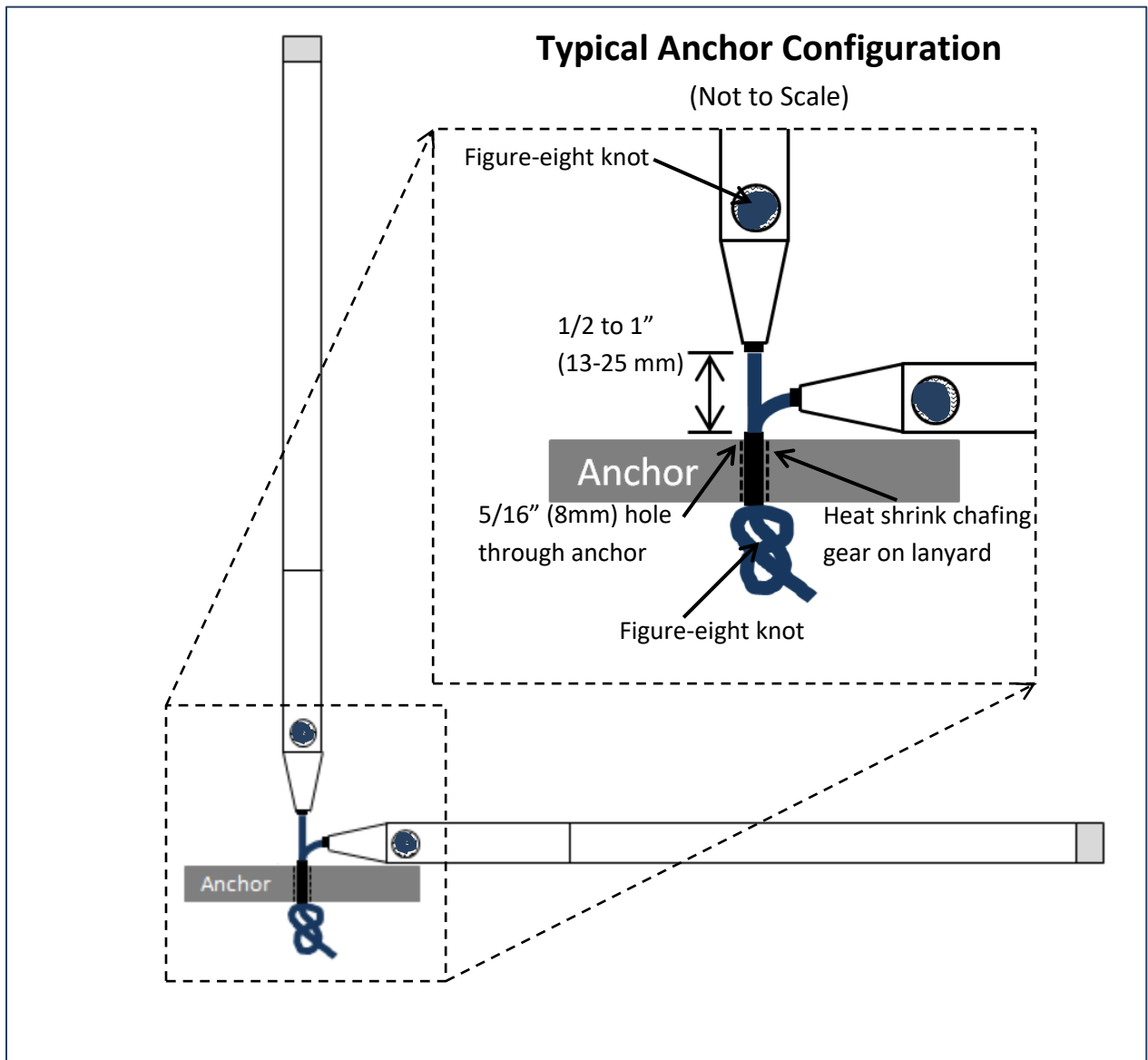

5. Do not replace the lanyard with a thicker or stiffer line or add chafing gear between the meter and the anchor. A stiff anchor line will increase the error of the instrument especially in low currents.

- Avoid attaching the TCM to sub-surface buoys or lines that may oscillate, vibrate or strum. The acceleration of the attachment point will induce error in the tilt/current calculation.

Tip: It is easy to make a replacement/custom lanyard. Use 3/16" or 5mm nylon or nylon/polyester flexible braided line with 1/4" heat shrink tubing (with melt-glue). If durability is a concern, use a more abrasion resistant line, rather than a thicker, less flexible line.

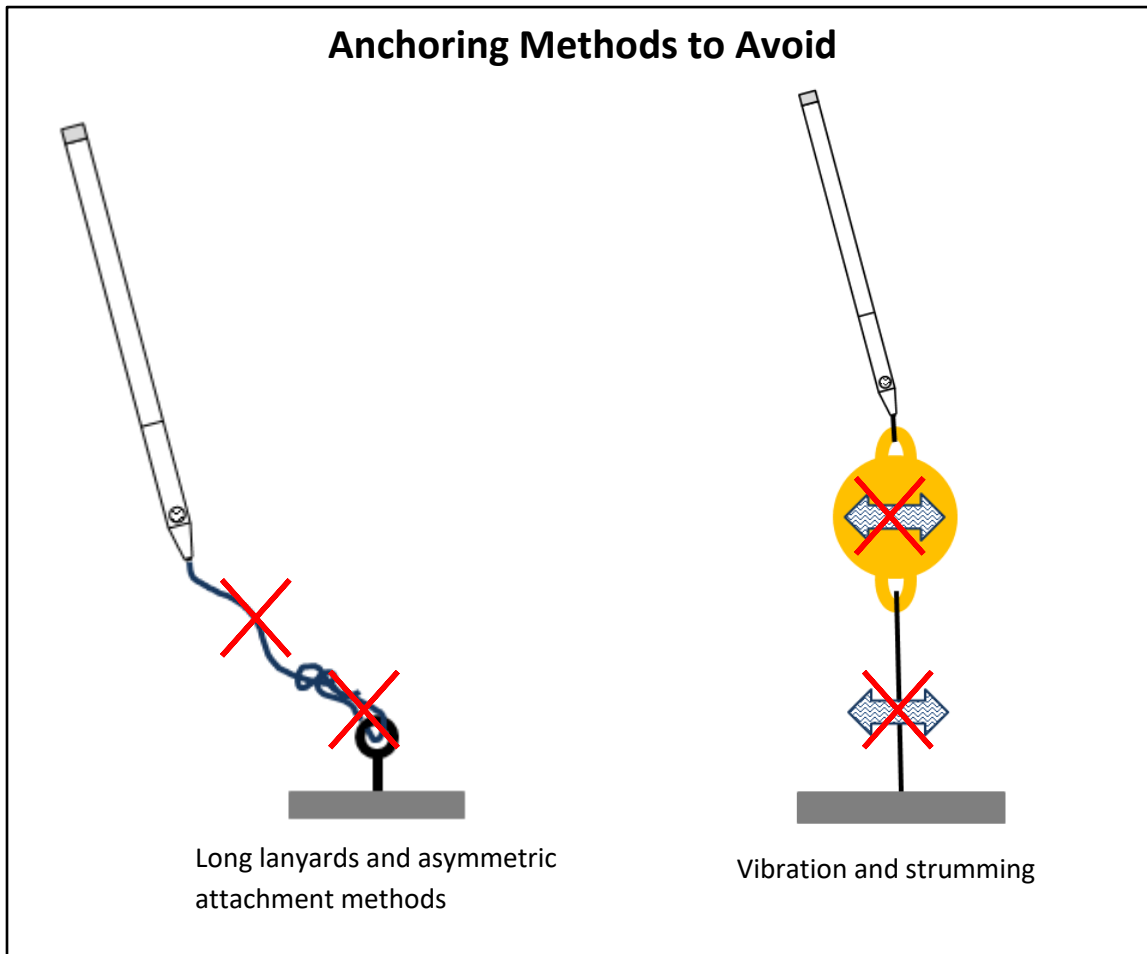

3.4 Other Deployment Considerations

- TCMs will only provide accurate current measurements when it is completely submerged. The meter may be used in low-energy intertidal zones or in intermittent rivers with but the water level should be recorded and data should be filtered out during periods of low water.
- TCMs are typically deployed on the bottom but it can be used above the bottom by attaching it to a rigid pole or tripod.
- Beware of bio-fouling. Barnacles, plants and other microorganisms may add significant error to the measurements by increasing the drag and buoyancy of the meter. For deployments where

bio-fouling is likely, the TCM should be cleaned regularly and/or anti-fouling paint should be applied. Consult someone with local knowledge as to what type of paint works best in your environment. However, traditional anti-fouling paint is filled with cuprous oxide and other metals that are denser than water and reduce buoyancy of the meter. There are several newer types of paint that do not contain metals and have a minimal effect on the performance of the meter. Contact Lowell Instruments to discuss before painting.

3.5 Data Retrieval and Conversion

When the deployment is complete, clean and dry the meter and remove the end cap. Connect the USB cable and use the “[Logger Status](#)” screen in MAT Logger Commander to stop recording data. Once logging has stopped Windows should automatically discover the MAT_LOGGER drive. Copy the binary file (.lid) to your local drive for processing.

The binary data is converted to velocity (speed and direction) using the “Convert Files” screen in MAT Logger Commander.

Use the drop-down menus to specify the model number, number of ballast washers and water type (fresh/salt). If the meter was deployed in a tidal estuary where the water type changes (with the tides) the file can be processed twice and the results compared. Contact Lowell Instruments if you have questions about selecting a calibration file.

Most users will want to select the check box “Average Burst Intervals.” When this check box is selected MAT Logger Commander will determine the average tilt and bearing from each “Burst Interval.” (If the meter was set to “Continuous” recording at 2-64 Hz, the averaging interval will be one second.)

Optionally, set the compass declination for your location to convert from magnetic North to true North. If you don't know the declination for your deployment location you can look it up here: <https://www.ngdc.noaa.gov/geomag-web/>. Note the declination is entered with east as positive, west as negative values.

The resulting file will end in “...CR.txt”. If the temperature channel was enabled there will also be a file ending in “...T.txt”. This second file will contain the temperature values. See [Convert Files](#) for more information on the format of the output files.

Tip: Always save the binary file (.lid) for your records. The binary file contains information that is not displayed in the output files and is an excellent backup file and can be used for debugging purposes.

4 TCM-1 Tilt Current Meter

This section is specific to the Model TCM-1 Tilt Current Meter and includes assembly, configuration, and hanging in an inverted position.

4.1 Assembling the Current Meter (TCM-1 Only)

If you have the TCM-3, 4, or 5 those models have loggers built into the housing and do not require additional assembly.

To assemble the TCM-1, screw the MAT-1 Data Logger into the end of the light grey pipe until tight. A firm grip is sufficient. Do not overtighten or use tools.

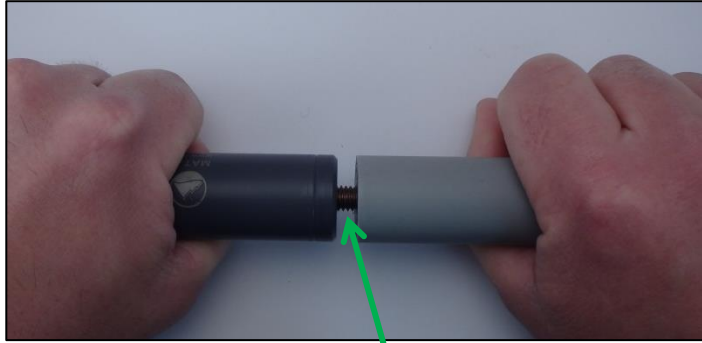

Use a firm grip and screw the logger all the way onto the threaded bronze stud until tight.

Tip: Thread-locker is not normally required but may be desired if the meter will be subject to rough handling or will be deployed in a challenging environment. If a thread-locker is used be sure to use a plastic-safe thread-lock such as Loctite® 425 or equivalent.

4.2 Selecting a Velocity Range (TCM-1 Only)

The TCM-1 may be configured to increase its sensitivity for low currents. By adding or removing the ballast washer at the top of the meter. (See *Product Data Sheet* for the recommended speed ranges.) The washer reduces the buoyancy of the meter and thereby increases the sensitivity of the instrument. The washer is secured by a bronze bolt (1/2" wrench required).

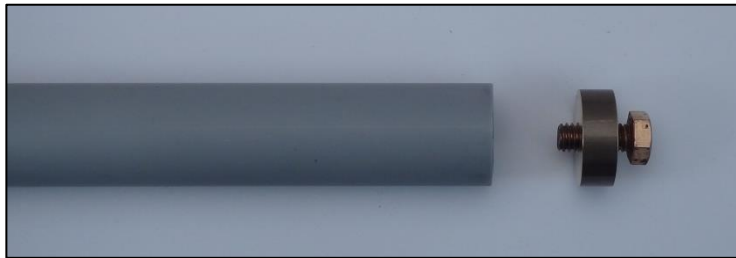

Caution: Use a 1/2" wrench but do not over-torque the ballast washer bolt. The threads in the housing are made from PVC plastic and can be stripped if the bolt is over-torqued.

Tip: If you do not know the velocity in the deployment environment, leave the ballast washer off for maximum range.

4.3 Deploying in an Inverted or Hanging Orientation (TCM-1 Only)

In some situations, it is desirable to mount the TCM-1 “inverted” or hanging, such as from a floating dock or fish pen. This section describes how to mount the meter in this “inverted” orientation. You will need the TCM-1 Inversion Kit and the bronze “low-range” ballast washer that came with the TCM-1 Current Meter Accessories Kit for a total of three ballast washers to assemble the meter for inverted orientation. Stack the three washers as shown and use the 1 ¼ inch bolt included in the kit to secure to the top of the meter.



Use 1/2 inch wrench.
Do not overtighten.

4.3.1 Site Selection

Movement and vibration of the anchor point, especially above the sampling frequency, adds error that is difficult to eliminate. Therefore, care must be taken when selecting a site for a top-mounted TCM to reduce or eliminate motion/oscillations/vibrations at the anchor point. Several factors that should be considered when selecting a site for a TCM are:

Water Velocity: *The TCM-1 is recommended for sites with water speeds of 0-80 cm/s. The maximum value is 120 cm/s. Accuracy between 80 and 120 cm/s is not specified.*

Waves: *The TCM is designed for sites with low wave energy. Avoid sites with breaking waves as the rapid acceleration of the TCM will break the quasi-static assumption and will add error to the measurements. Waves are even more of a concern for meters deployed near the surface. Even when oversampling and filtering are used, the meter will be more accurate in relatively protected environments, such as protected harbors and coves, or deployed at least twice the wave height below the surface.*

Anchor Point: *The ideal anchor point is a fixed structure because it will eliminate the possibility of movement of the anchor point. But fixed structures are often not available, so the next best attachment point is a large floating dock, fish pen or other anchored floating structure. Small floats and buoys should be avoided because they are much more likely to move/oscillate/sway due to wind, waves and currents.*

4.3.2 Mounting the Meter

The TCM is supplied with a flexible lanyard for mounting to an anchor or other hard point. There are many ways to mount the meter but there are several factors that will improve the quality and accuracy of the data.

Mount the lanyard in such a way that the lanyard length does not change based on the direction of pull. This is typically done by drilling a hole through the anchor and knotting the lanyard on the back side (see Figures 2A, 2B and 3A, 3B, 3C).

Limit the lanyard to 2 cm (3/4 inch) or less (see Figure 2B). The lanyard should only be long enough to allow for full range of motion. Long lanyards may result in the meter oscillating, bumping into the anchor or even moving into the “wake shadow” of the attachment point.

If the TCM will be mounted on a floating dock, mount the meter towards the middle of dock to minimize motion from waves and dock loading (Figure 4).

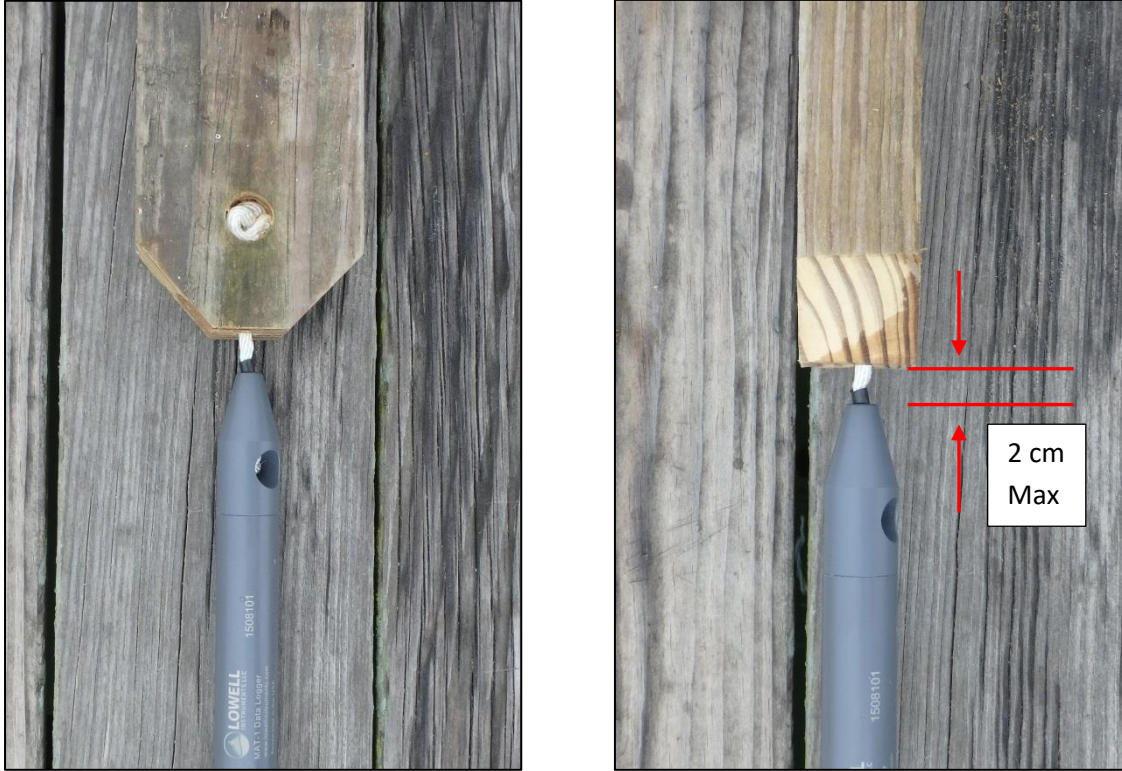

Figure 2A & 2B: Recommended mounting method using dimensional lumber. A hole is drilled through the end of the board with a second hole for the knot (left). The lanyard length is limited to less than 2 cm (right).

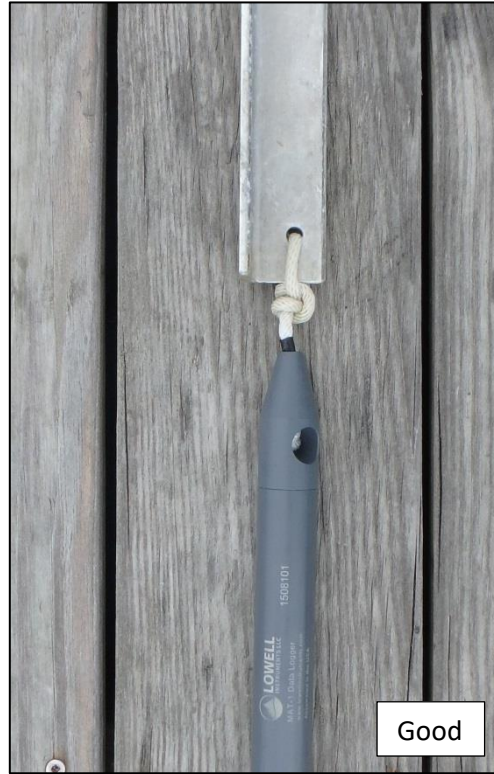

Figure 3A (top left): The recommended mounting method for an aluminum bracket is to drill through the bracket, deburr the hole and knot on the back side.

Figure 3 B (top right): If drilling through is not an option, tie the lanyard short and tight against the mounting point.

Figure 3 C (bottom left): Avoid loose knots that can get fouled and may pull asymmetrically when the current changes direction.

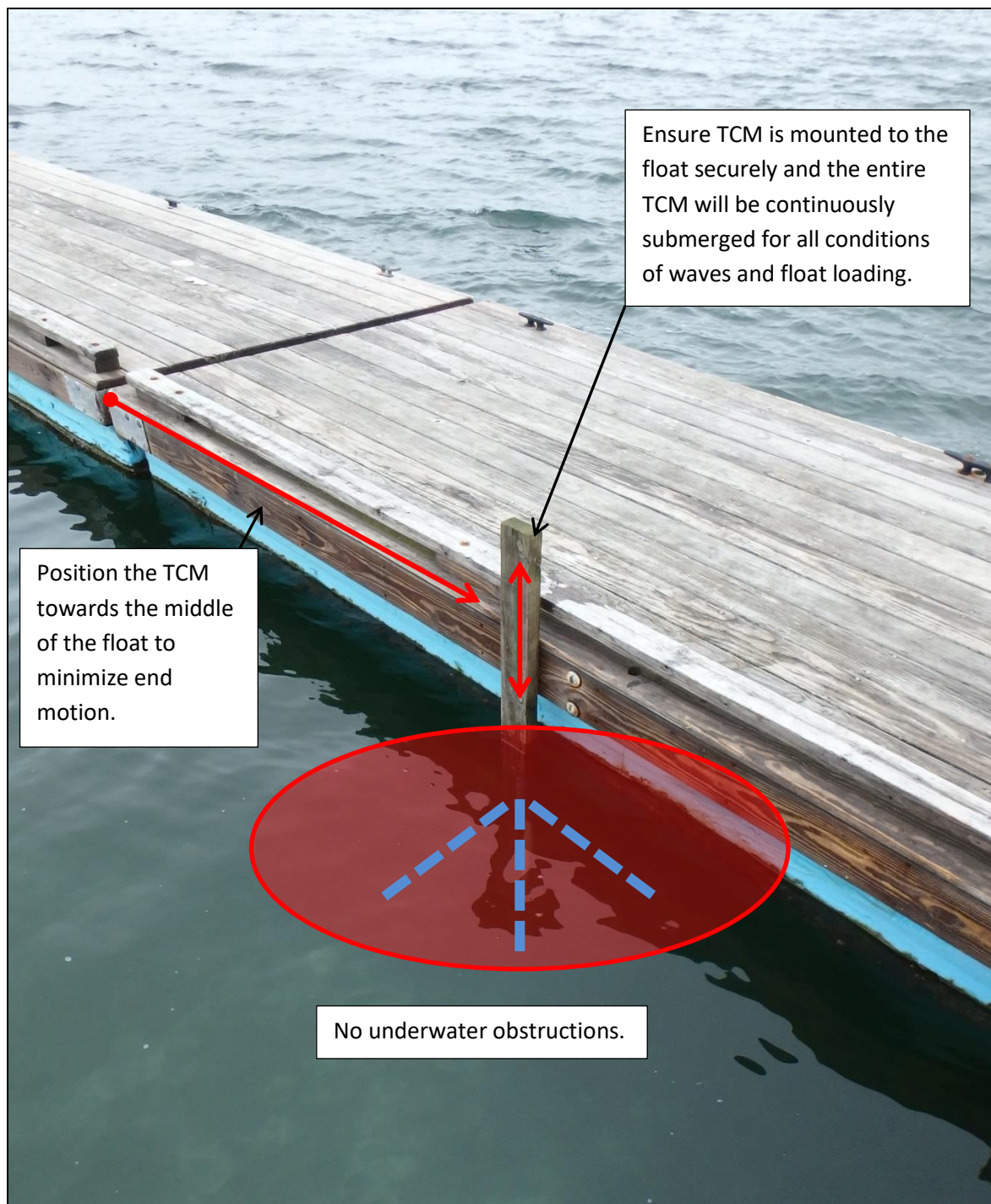

Figure 4: Suggested mounting on a floating dock. Meter is free from obstructions, fully submerged and away from the more lively ends of the dock.

4.3.3 Data Post Processing

Data conversion for the inverted logger is very similar to conversion of binary data from a bottom mounted TCM. The only difference is that you will select “3” ballast washers. The “inversion” is automatically applied by the software.

5 Logging Modes & Setup File

The MAT-1 logger has several recording modes that allow you to customize the logger run for a specific application. These options are defined below.

Deployment Description

Enable Channels and Specify Recording Intervals

Operational Indicator Control

Set Start and Stop Times

5.1 Deployment Description

This field is useful for labeling your deployments. The description will be combined with the logger's serial number and file number to form a unique data file name. For example, if the description was Test and the logger serial number is 123456, the data file name will be 123456_Test_(0).lid.



were stopped and restarted with the same MAT.cfg file, the new data file would be 123456_Test_(1).lid.

Tip: Descriptions are limited to 15 characters and must not contain any spaces or special characters other than “_” or “-”.

5.2 Operational Indicator Control

The logger contains two light emitting diodes (LEDs) that serve as operational indicators. There is one red and one green LED.

The red LED is reserved for errors and cannot be controlled. If the red LED is illuminated or flashing, you should check the logger's status in the “Logger Status” tab and consult the troubleshooting guide.

The green LED has two purposes. First it illuminates when the logger is connected to a USB port. Second, it can be configured to blink by checking the “Enable LED while logging” check box. See below for a complete description of LED behavior:

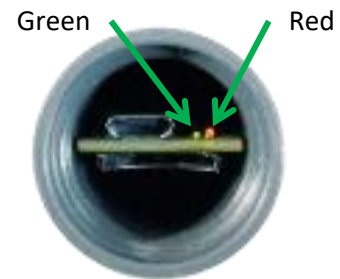

Blink LED on temperature measurement

LED Behavior

The MAT has two operational indicators: one red and one green LED.

Green LED

When the logger is connected to a USB port the green LED will turn on. The user may optionally enable the green LED to turn on when logging by enabling the LED when the setup file is created. If enabled, the LED will blink when logging. There are two behaviors that are dependent on the firmware version.

Firmware version 1.8.32 and above

USB State	Operating Mode	Green LED
Connected	Stopped	Off
	Waiting for start time	Blink every 4 seconds
	Running	Blink every 2 seconds

Firmware version 1.0.124 and below

USB State	Operating Mode	Green LED
Connected	Stopped	Off
	Waiting for start time	Off
	Running	Blinks at the same rate as the temperature interval

Red LED

The red LED indicates that there is a serious error, such as a failing battery or memory card error. Depending on the type of error and the firmware version, the LED may be on continuously or may be blinking, but either way, if the red LED is on the logger should be connected to a PC and the status message in the Start/Stop/Status screen should be checked to determine the cause of the error.

Power Applied/ Reset

When the power is applied or the board is reset, the logger blinks both red and green LEDs 4 times.

5.3 Enabling and Disabling Logging Channels

The logger's three sensors can be turned on or off independently. Check or uncheck the channels as desired. Disabling a sensor that is not needed for an application prolongs battery life and results in a smaller data file. See "Battery Life" for more information.

5.4 Recording Rate & Burst Mode

The MAT-1 logger allows the temperature sensor recording interval to be set independently from the recording rate of the magnetometer and accelerometer.

Both sensors have a minimum recording rate of one sample per hour. But they have different maximum sampling rates. The magnetometer and accelerometer sensors may be recorded at up to 64 samples per second (64 Hz). While the maximum rate for the temperature sensor is 1 sample per second (1 Hz).

The magnetometer's and accelerometer's logging interval is set by using the "Burst Interval", "Burst Rate," and "Burst Duration" in combination. These three settings allow the logging interval to be set to record continuously (Examples A & B) or to utilize non-continuous "Burst Logging" (Example C).

When the logger is configured for "Burst Logging" it records at the "Burst Rate" for the "Burst Duration" and then it switches to a low-power sleep mode for the remainder of the "Burst Interval". The process repeats until the logger is stopped. "Burst Logging" conserves battery life and reduces the size of the data file.

There are some limits to using burst mode. The total amount of data that is collected during a "Burst Interval" must not exceed 32K bytes. The software will issue a warning if this limit is reached. The typical solution is to reduce the burst duration, or to more closely match the temperature interval with the magnetometer & accelerometer intervals.

Tip: Burst Logging is useful for long deployments where battery life is the limiting factor and there are high frequency signals that need to be recorded for post processing.

Accelerometer and Magnetometer

Accelerometer Magnetometer

Burst Interval: 1 Minute

Burst Rate: Burst Off

Burst Duration [seconds]: 0 Continuous

Example A: 1-minute logging interval (1 sample per minute).

Accelerometer and Magnetometer

Accelerometer Magnetometer

Burst Interval: 1 Second

Burst Rate: 16 Hz

Burst Duration [seconds]: 1 Continuous

Example B: Continuous logging at 16 Hz (960 samples per minute).

Accelerometer and Magnetometer

Accelerometer Magnetometer

Burst Interval: 1 Minute

Burst Rate: 16 Hz

Burst Duration [seconds]: 10 Continuous

Example C: Intermittent logging with a 10 second "burst" at 16 Hz with 50 seconds of sleep per minute (160 samples per minute).

5.5 Temperature

It is recommended that the temperature be enabled even if it is not required. First, it is used to temperature compensate the magnetometer. Second, it is often helpful to see the temperature, even if only qualitatively. The temperature interval must be equal to or greater than the burst interval.

5.6 Start and Stop Times

You can program the logger to start and stop at specific times. This feature is helpful when one or more loggers need to be synchronized with another clock, when the logger is being started before it will be deployed, or when the deployment has a known end time.

Note: Even if a start time is used, the logger must still be started by clicking the “Start Logging” button in the “Logger Status” tab. Once the logger has been started, it will read the start time from the setup file and delay the start of logging until the logger’s clock equals the start time. The logger status will show “Waiting for Start Time” in yellow.

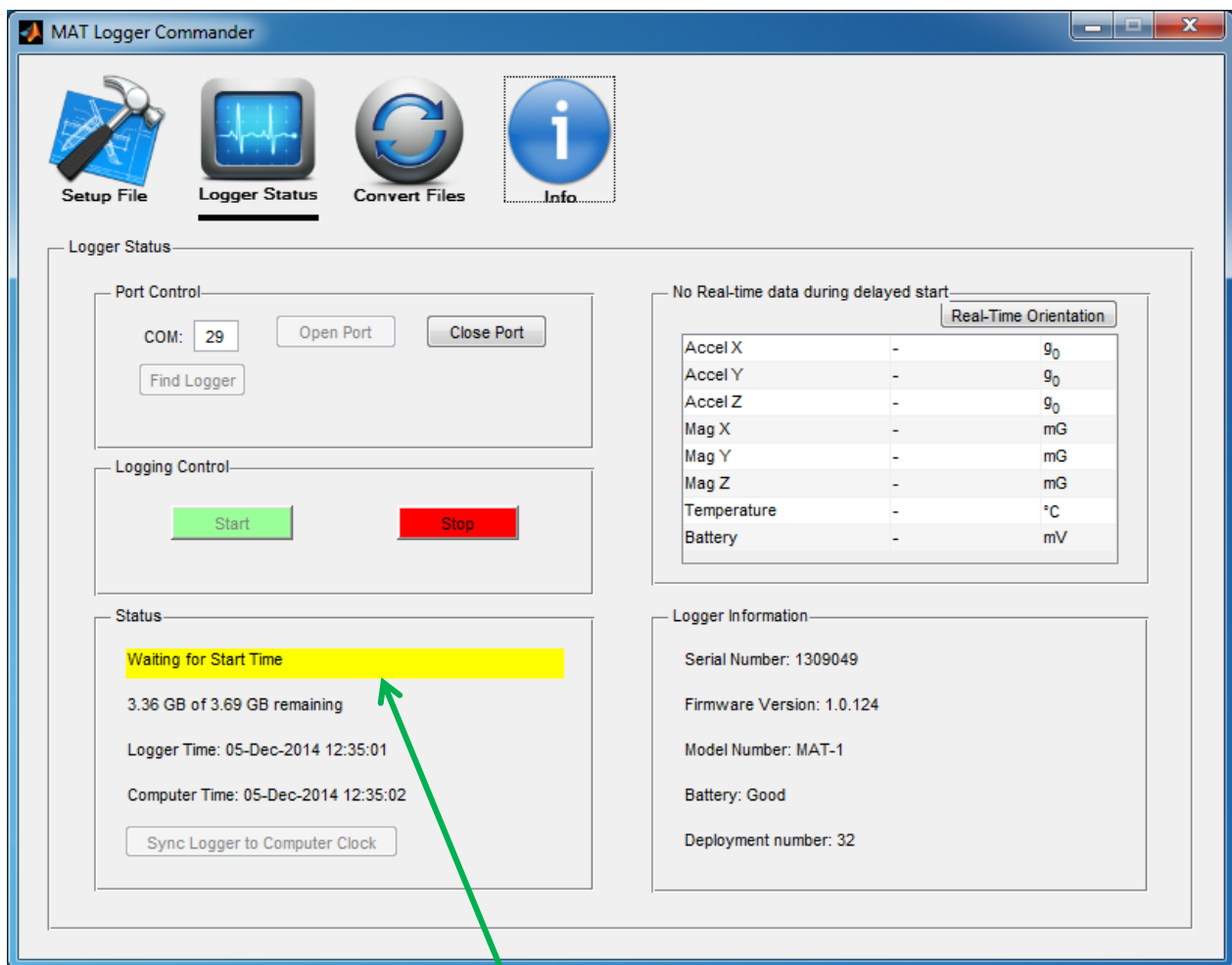

Waiting for Start Time

If “Start Logging” is clicked after the “Start Time” time has passed, the logger will immediately start collecting data and will display “Running” (in green).

If both the start and stop times are in the past with respect to the logger’s clock, it will not start and will display an error state (in red).

If no stop time is set, the logger will continue logging until either the logger is stopped by the user, the battery fails, the memory card fills, the file size reaches 3.9 GB, or there is an error (such as the memory card is removed, which is impossible on one battery).

Note: When the logger is set for “No Delayed Start,” it may take up to two seconds for the logger to start collecting data. During this time, the Logger Status screen may display “Waiting for Start”. This is normal and occurs because the logger needs to read the setup file from the SD card, start writing the data file, and wait for the next whole second before starting.

6 Logger Status

The Logger Status screen displays information about the connected logger. The screen is broken up into five sub screens each with a specific purpose.

The screenshot shows the MAT Logger Commander software interface. At the top, there are four icons: Setup File (a hammer and blueprint), Logger Status (a monitor with a pulse line), Convert Files (a circular arrow), and Info (an information icon). The Logger Status screen is active and contains several sections:

- Port Control:** Includes a COM port dropdown set to 29, Open Port, Close Port, and Find Logger buttons.
- Logging Control:** Features a green Start button and a red Stop button.
- Status:** Displays "Running - File size: 33.86 KB" in a green bar, followed by "3.36 GB of 3.69 GB remaining", "Logger Time: 05-Dec-2014 12:35:52", "Computer Time: 05-Dec-2014 12:35:53", and a Sync Logger to Computer Clock button.
- Last recorded data:** A table showing real-time orientation data:

	Real-Time Orientation
Accel X	-0.8931 g ₀
Accel Y	-0.4531 g ₀
Accel Z	0.0211 g ₀
Mag X	-105 mG
Mag Y	-162 mG
Mag Z	124 mG
Temperature	21.4997 °C
Battery	3.6920 V
- Logger Information:** Lists Serial Number: 1309049, Firmware Version: 1.0.124, Model Number: MAT-1, Battery: Good, and Deployment number: 33.

6.1 Port Control

The MAT-1 logger uses a USB COM port for communications. Select “Find Logger” for the software to scan the available COM ports for an attached MAT-1 logger. Alternatively, if you know the COM port number, enter it directly. Selecting “Open Port” initiates communication with the logger. “Close Port” ends communication with the logger. Note: It is not necessary to close the port before disconnecting the logger.

6.2 Logger Control

When “Start Logging” is clicked, the logger will close the removable drive and look for a setup file on the SD card. If it finds a setup file, it will check the start time and either start immediately or wait until the start time is reached.

If “Stop Logging” is clicked, the logger will stop taking measurements, close the data file, and re-open the removable drive.

6.3 Status

The Status window displays information about the current state of the logger.

- State: The logger’s status is highlighted in green when the logger is running, yellow when it is delayed and red when it is stopped, or when there is an error.
- Free Space: The second row contains the amount of free space and total space on the microSD card.
- Logger Time & Computer Time: The last two rows show the current time of your computer and the logger.
- Sync Logger to Computer Clock: Clicking this button loads the computer’s time in the logger. This button is only enabled when the logger is stopped.

6.4 Sensor Data

This table lists the currently available values for the logger’s sensors. Depending on the logger’s state, the values may or may not be real-time. If the logger is stopped, the values are updated every second. If the logger is running, the values are updated every second or as frequently as the sensors are logged. If the logger’s intervals are set to 1 minute, the display will only update once per minute. If a channel is disabled, that sensor’s values will be frozen at the last measured value (prior to the start of the deployment).

6.5 Logger Information

These five fields include logger specific information:

- Serial Number: This unique number matches the number on the case and can be used to identify the logger and data file. See “Serial Number” below for more information.
- Firmware Number: This is the version number of the embedded software (firmware) in the device. See “Firmware Updates” for more information.
- Model Number: This is the hardware model number.

- Battery State: There are only two battery states: “Good” or “Bad.” See “Battery Information” for more information.
- Deployment Number: This number is incremented every time the logger is started. The number is stored in the logger in non-volatile memory. It can be used to track deployments and as an estimate of data logger use.

7 Convert Files

The MAT-1 Logger records data in a binary file format. While the binary file is a simple and reliable format and conserves the logger’s battery life, it is not usable by common third-party tools such as spreadsheets or plotting packages. MAT Logger Commander is used to convert the binary file into a comma separated values text file that can be used by other software. To convert a file, go to the “Convert Files” icon, and you will see the following screen:

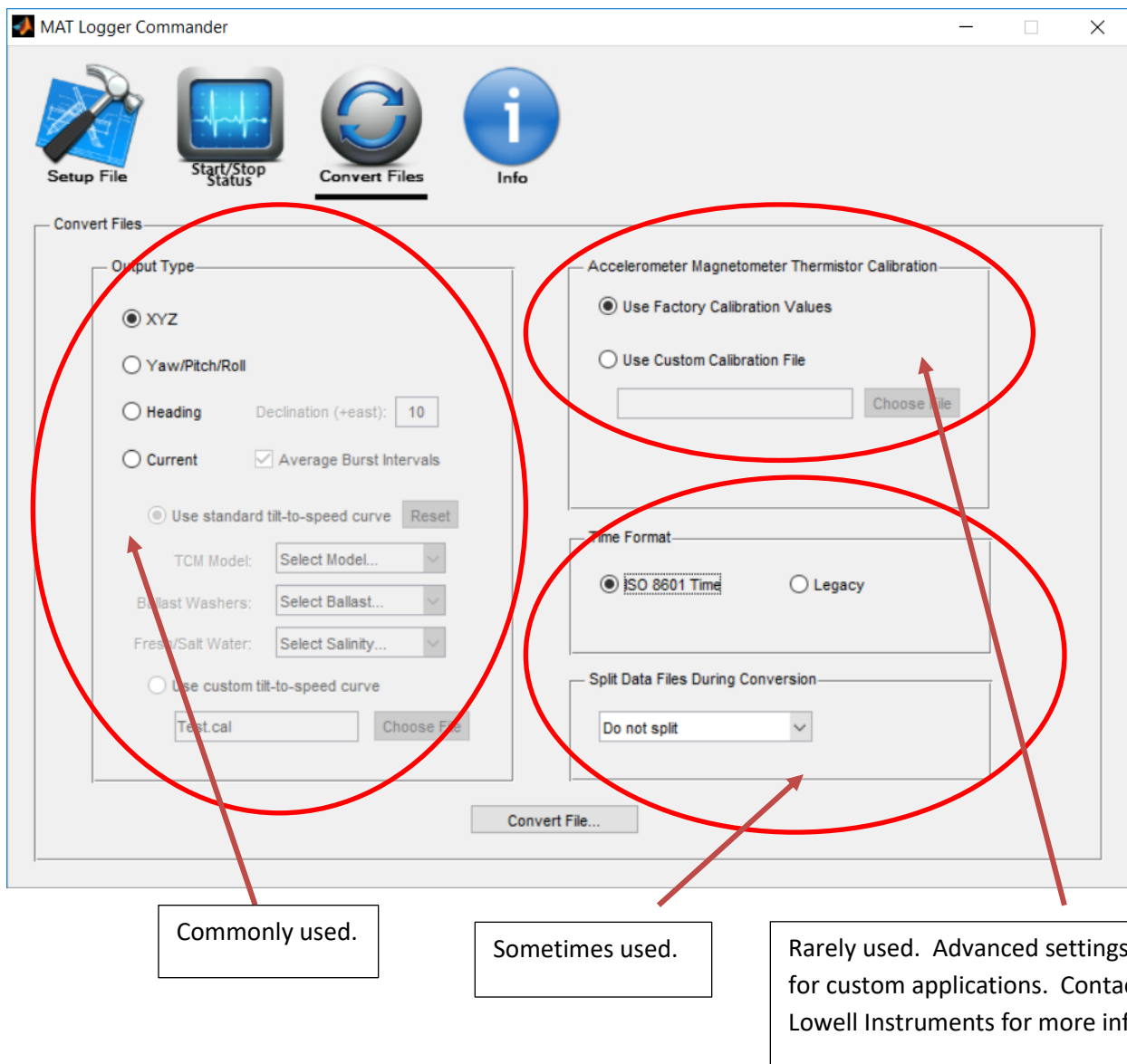

7.1 Output Type

There are three output types that are currently supported by MAT Logger Commander:

7.1.1 XYZ

This output type contains all of the magnetometer, accelerometer and temperature data. The only processing of the data by MAT Logger Commander is to apply calibration coefficients to the raw sensor data. The magnetometer and accelerometer values are presented in their native components X, Y and Z with units of milli-gauss (mG) and standard gravity (g). The temperature values are reported in degrees centigrade (C).

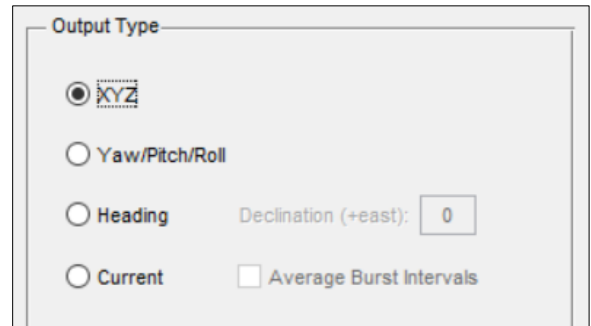

Magnetometer and Accelerometer Column Headings:

Date & Time	Ax (g)	Ay (g)	Az (g)	Mx (mG)	My (mG)	Mz (mG)
-------------	--------	--------	--------	---------	---------	---------

Temperature Output File Column Headings:

Date & Time	Temperature (C)
-------------	-----------------

7.1.2 Yaw/Pitch/Roll

This output type converts the magnetometer and accelerometer data to yaw, pitch, and roll with units of degrees. The fundamental assumption is that the logger is quasi-static (i.e. it is not accelerating or rotating rapidly). Yaw is defined as rotation about the z-axis, pitch as rotation about the y-axis, and roll as rotation about the x-axis. Positive rotations are defined as counterclockwise when looking along the rotation axis toward the origin. Yaw and roll have the range of -180° to 180° degrees; pitch has the range of -90° to 90° . Yaw, Pitch, and Roll will all be zero when the X, Y, and Z axes are aligned North, East, and Down respectively. Orientation angles are applied in the order: yaw, pitch, roll. The yaw output is presented as degrees from magnetic north but does not support adjustment for declination. The yaw/pitch/roll convention to make sense, the logger should be mounted on the vehicle/object with the end cap “up” and the SD card side of the logger board facing “forward.”



Pitch/Yaw/Roll Output Column Headings:

Date & Time	Yaw (degrees)	Pitch (degrees)	Roll (degrees)
-------------	---------------	-----------------	----------------

Temperature Output Column Headings:

Date & Time	Temperature (C)
-------------	-----------------

7.1.3 Heading

This output type converts the magnetometer and accelerometer data into compass heading from 0-360 degrees with the end cap end of the logger defining the “forward” direction (i.e. the end cap is pointing towards the front/bow of the vehicle/platform).

The logger’s heading is relative to the Earth’s magnetic field and can be adjusted by entering a compass declination. If you don’t know the declination for your deployment location you can look it up here: <https://www.ngdc.noaa.gov/geomag-web/> (Note the declination is entered with east as positive, west as negative values.)

For the heading to be meaningful, the logger must be mounted approximately horizontally. The software will automatically compensate for pitch and roll of the attachment point but is more accurate for if the pitch is less than 45 degrees. Note that the fundamental assumption in the heading calculation is that the logger is quasi-static (i.e. it is not accelerating or rotating rapidly). The accuracy will suffer as this assumption breaks down due to non-static conditions.

Heading has the option of averaging data over the “burst interval.” When averaging is enabled the X, Y and Z vector components are averaged and then the heading is calculated. Temperature is only averaged if the temperature recording rate is faster than the magnetometer/accelerometer recording rate (this is unusual).

Heading Column Headings:

Date & Time	Heading (degrees)
-------------	-------------------

Temperature Output Column Headings:

Date & Time	Temperature (C)
-------------	-----------------

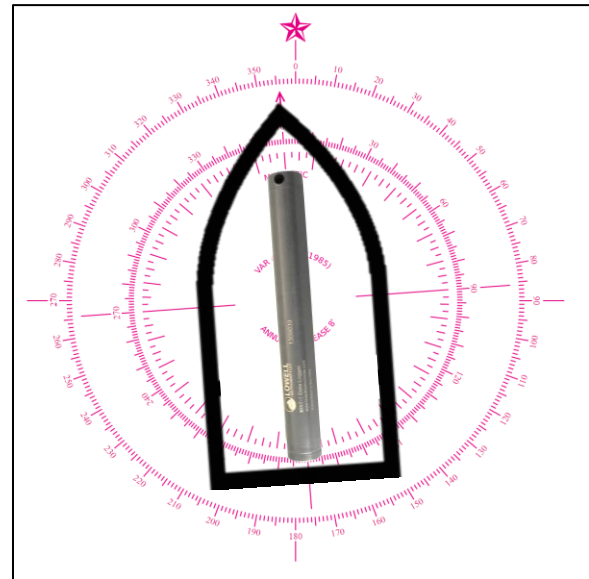
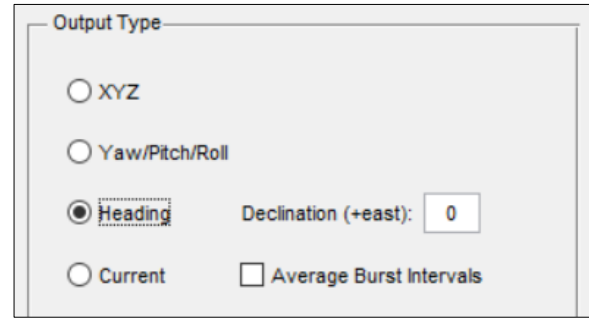

7.1.4 Current (Tilt Current Meter)

This output type is specific to use with tilt current meters. (See Section 3 “[TCM Current Meter](#)” for details of using Lowell Instruments’ current meter). The software uses a calibration file to convert tilt and direction of tilt (bearing) to water speed and direction. Calibration files are specific to model numbers, ballast washers and water type (fresh/salt).

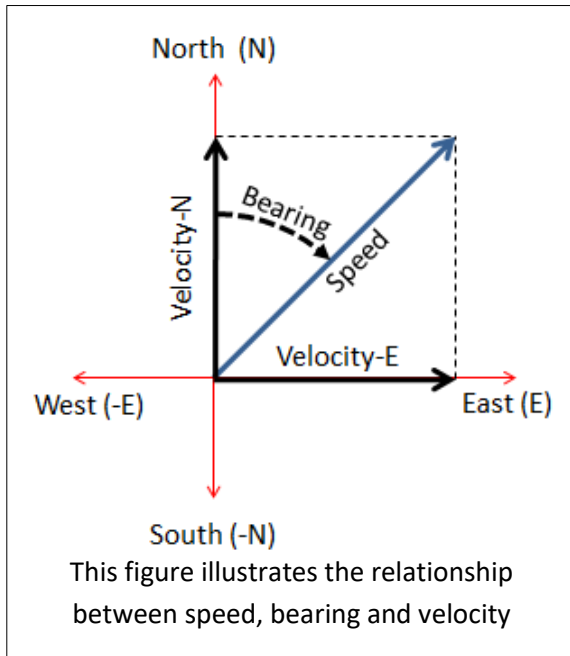

Output Type

XYZ

Yaw/Pitch/Roll

Heading Declination (+east):

Current Average Burst Intervals

Use standard tilt-to-speed curve

TCM Model:

Ballast Washers:

Fresh/Salt Water:

Use custom tilt-to-speed curve

First select the TCM Model. Then specify the number of ballast washers (if any) and water type. If the water type varies (for example the meter was deployed in a tidal estuary) the file can be processed twice and the results compared. Contact Lowell Instruments if you have questions about selecting the correct calibration file and for making adjustments for salinity.

The output file contains two pairs of redundant data presented, for convenience, in two formats. In some applications “Speed” and “Bearing” will be most convenient. For other applications the velocity is provided in north and east components. Negative values represent current to the south and west respectively.

Current has the option of averaging data over the “burst interval.” When averaging is enabled the X, Y and Z vector components are averaged and then the speed and bearing is calculated. Temperature is only averaged if the temperature recording rate is faster than the magnetometer/accelerometer recording rate (this is unusual).

Current Output Column Headings:

Date & Time	Speed (cm/s)	Bearing (degrees)	Velocity-N (cm/s)	Velocity-E (cm/s)
-------------	--------------	-------------------	-------------------	-------------------

Temperature Output Column Headings:

Date & Time	Temperature (C)
-------------	-----------------

7.2 Time Format

There are two time format options:

- “ISO 8601 Time” is an international standard where the time is one field: YYYY-MM-DDTHH:MM:SS.SSS.
- “Legacy” is an unofficial format that is used by some plotting software and spreadsheets. The date and time separate into two fields: YYYY-MM-DD,HH:MM:SS.SSS.

7.3 Split Data Files During Conversion

The MAT-1 logger is capable of creating binary files that are several gigabytes in size. These files are large but manageable by most systems. However, the text files that are produced during a conversion are 6-10 times larger than the binary files (depending on channel settings) and are unmanageable for many systems and software (the file will not open or will be truncated).

MAT Logger Commander has an option that will limit the size of the text files. Utilizing “Split Data Files During Conversion” allows the user to instruct the software to create multiple smaller text files based on smaller parts of the binary file. The size options range from 5 to 40 MB resulting in text files with a maximum size of 30 to 400MB. These smaller files may be easier to work with.

7.4 Calibration Coefficients – OEM Use Only

Use Factory Calibration Values. The MAT-1 logger’s sensors are calibrated at our production facility. A set of calibration coefficients for the magnetometer, accelerometer, and temperature channels are stored in the logger. The calibration coefficients are applied when the binary data is converted to text data.

MAT Logger Commander includes an option to allow third party manufacturers (OEM’s) to use custom calibration coefficients. Select “Use Factory Calibration Values” to use the coefficients that are stored in the binary data file or select “Use Custom Calibration File” to use an alternate set of coefficients. Contact Lowell Instruments for more information about creating custom sensor calibration files.

8 Sensor Information

The accelerometer and magnetometer sensors are solid-state integrated circuits designed for use in consumer products such as cellular phones, game controllers, and personal navigation systems. The temperature sensor is a precision thermistor. Detailed information on sensor performance can be found in the relevant *Product Data Sheets*.

8.1 Sensor Orientation

The accelerometer and magnetometer are oriented such that the X, Y and Z axes follow the right hand-rule. The accelerometer produces positive values on an axis when the axis pointed down towards the center of the earth. The magnetometer produces positive values on an axis when the axis is aligned towards a magnetic north pole.

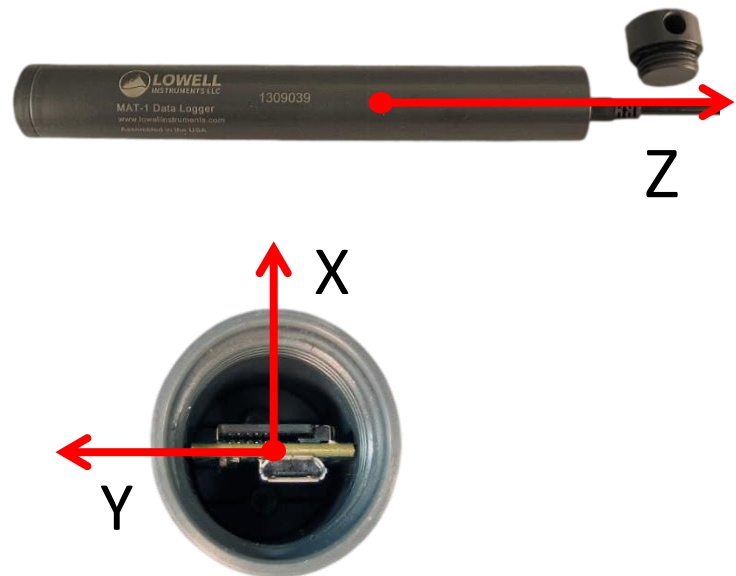

- The Z axis is parallel to the length of the case, with the positive direction towards the removable end cap and USB connector.
- The X axis is perpendicular to the circuit board with the positive direction upwards from the microSD socket.
- The Y axis is in the plane of the circuit board with the positive axis to the left of the USB connector as viewed looking into the logger with the USB connector and LEDs facing down.

8.2 Magnetometer

The magnetometer is a temperature compensated three-axis integrated circuit. The sensor measures absolute magnetic field strength. The magnetometer's data can be used to determine the compass bearing with respect to the logger's orientation or to determine magnetic field strength and orientation.

The logger circuit board and housing were designed to use the absolute minimum of ferrous components so as to minimize hard and soft iron effects.

The magnetometer's response can be shifted if the sensor is subject to magnetic fields of greater than ~100 Gauss. Keep "rare earth" magnets well away from the logger as they can induce a semi-permanent offset of several hundred mG. Loggers that have been subjected to a strong magnetic field will need to be recalibrated and/or degaussed (contact Lowell Instruments).

8.3 Accelerometer

The accelerometer is a three-axis micro-electro-mechanical system (MEMS) inertial sensor. The data can record for tilt-quasi-static orientation calculations as well as activity monitoring and recording “g-forces”.

The accelerometer measures projections of the acceleration vector (a-g) onto the MAT-1 axes. Thus, the vector sum of the X, Y and Z axes will register a magnitude of approximately 1 g while at rest on the surface of the earth.

The sensor operates at 1600 Hz with 12-bits of resolution and holds the most recent values in a 32 value first-in-first-out buffer (FIFO). The MAT-1 reads the contents of the FIFO buffer for each measurement and averages the results. The recorded value is stored as a 14-bit value. The result of this process is that there is both an increase in resolution and a reduction in noise.

8.4 Thermistor

The logger has an instrumentation-grade Negative Temperature Coefficient thermistor. The resistance measurement is made with an instrument-grade 16-bit analog to digital converter (A/D).

The temperature sensor is located approximately in the center of the logger. The sensor has a low-pass filter with a cut-off frequency of 16 Hz, which substantially reduces noise from 50/60Hz electromagnetic interference. The sensor has a relatively slow time response, making it very good at averaging ambient temperatures.

The accuracy and resolution of the sensor is dependent on the temperature. The logger has a “standard range” and an “extended range”. The accuracy and resolution are higher in the “standard range” than in the “extended range”. All loggers are capable of recording temperature in both ranges. Consult the *Product Data Sheet* for details.

9 Logger Maintenance

9.1 O-Ring Care

The MAT-1 Logger will be damaged if water enters the housing. It is very important that the O-ring be kept clean and in good condition. Hair, sand, and grit can all cause leaks and should be wiped away with a lint-free cloth. The O-ring comes pre-lubricated from the factory and should be periodically re-lubricated with O-ring lubricant.

Tip: Do not over tighten the end cap. Hand tight only. Over torquing the end cap will not increase the sealing characteristics of the O-ring and may make the cap difficult to re-open.

The O-ring is made of EPDM rubber. EPDM performs well in water but is not compatible with petroleum-based materials.

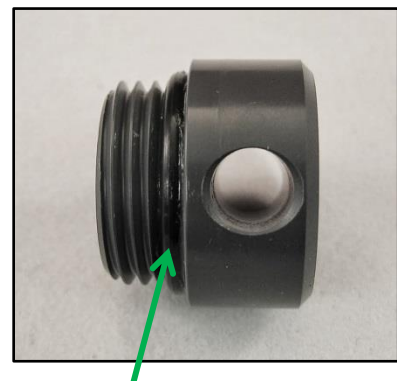

Lubricate O-ring

Tip: Always check the O-ring for dirt/hair/sand/lint and signs of damage and replace and clean it before any underwater deployments. Carefully remove the O-ring with non-metallic, non-scratching tools and replace with a new O-ring.

One pre-lubricated spare O-ring is included with the logger. Additional replacement O-rings and lubricant may be purchased from Lowell Instruments. These materials are also available from many industrial supply houses. Contact us for the type for your device. *The recommended lubricant is Dow Corning® 111 Valve Lubricant and Sealant.*

9.2 Logger Housing Care

The logger housing is designed to be used in a wide variety of operating environments. Minimal maintenance is required, but care must be made to ensure that moisture stays out of the housing.

Salt water damages electronics. Extra care should be taken before opening the logger if it has been used in salt water. Always rinse the logger with fresh water after it has been used in salt water. Wipe the logger dry with a dry cloth before opening the end cap. After opening, check to see if any water droplets entered the housing, and, if they did, immediately wipe them away with an absorbent cloth.

The logger contains desiccant within the housing. The desiccant will control the relative humidity in the logger and prevent condensation under normal operation. But it does not have the capacity to absorb droplets of water. The logger should be stored with the end cap installed so that the desiccant is not exposed to the atmosphere indefinitely.

9.3 SD Card

The MAT-1 logger uses a microSD card for non-volatile storage. When the logger is connected to a Windows computer using the USB cable, the card will appear as removable storage on Windows computers.

Tip: Windows assigns a drive letter based on the physical USB port. If your drive letter keeps changing, it is because you switched USB ports on your machine.

In order to prevent file conflicts, the card will not be available when the logger is collecting data.

But if the logger is stopped, the media will reappear automatically in “My Computer” in Windows. Cards that were supplied by Lowell Instruments will be labeled with the name “MAT_LOGGER” in Windows Explorer.

9.3.1 Ejecting the Card

The logger has a “push-push” type card socket. To eject the card, gently push the card into the socket, and it will spring back out. To re-insert the card, align the notch to the right, and push the card back into the socket. Do not eject the SD card while the logger is operating. It is not possible to “hot swap” cards; the logger must be stopped and restarted with MAT Logger Commander.

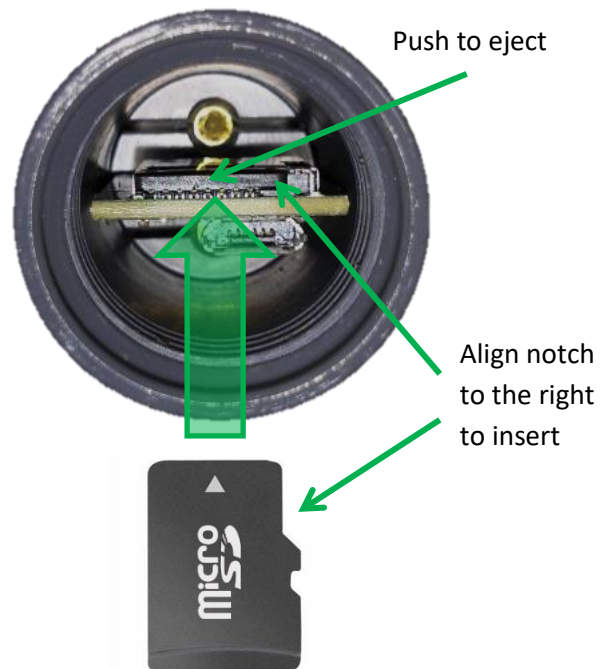

Tip: The MAT-1 logger transfers files over USB more slowly than a dedicated USB card reader. If a file is larger than 10-20 MB, it is usually faster to eject the card and read the card directly with a USB card reader.

9.3.2 Reformatting the SD Card

The microSD card should not require reformatting if it is solely used with the MAT-1 logger. But we recommend reformatting the card if it has been used by other devices such as cameras, smart phones, etc. because these devices may clutter the file allocation table and increase write times.

The card must have the FAT32 format. For best results, use the official SD Association formatting tool at https://www.sdcard.org/downloads/formatter_4/. The SD Association program formats the card according to the FAT-32 and SD card specifications which helps to ensure interoperability with the MAT-1 Logger.

Tip: The card can be formatted in the logger or with a card reader. But it is substantially faster to eject the card and format it in a card reader.

9.3.3 Card Type

The MAT-1 logger is theoretically compatible with all microSDHC cards of up to 32GB that have the FAT32 file system. But the logger has only been tested with a very small subset of the hundreds of

brands and models of microSD cards. Testing at Lowell Instruments has shown that while a card may technically be functional, all cards are not equal. Different model cards from the same “name brand” manufacturer may perform significantly differently. Of particular concern is that some cards have slow write speeds and use more battery than other cards.

Lowell Instruments purchases microSD cards from a reputable supplier and tests supplied makes and models to ensure that it is compatible with the MAT-1 logger. Contact Lowell Instruments if you would like to get an up-to-date list of recommended replacement microSD cards.

9.4 Battery Information

The MAT-1 logger contains a lithium thionyl chloride non-rechargeable “A” (NOT “AA”) size battery. Lithium thionyl chloride batteries have very high energy density and are used in several common devices such as natural gas meters and automatic toll transponders. Lithium thionyl batteries perform well in a wide range of temperatures and have a much lower self-discharge rate of about 1-2% per year compared to lithium-ion batteries, which typically lose 10% or more per month.

Warning: *This logger contains a lithium battery. Do not cut open, incinerate, heat above 85°C (185°F), or recharge the lithium battery. The battery may explode if the logger is exposed to extreme heat or conditions that could damage or destroy the battery case. Do not dispose of loggers or batteries in fire. Do not expose the contents of the batteries to water. Dispose of the batteries according to local regulations for lithium batteries.*

The MAT-1 logger draws power from the USB port when it is connected but does not recharge the battery. If the battery has failed, the logger will operate when connected to a USB port and data can be offloaded and sensor values checked. But the status screen will indicate, in red, that the battery has been discharged and should be replaced.

9.4.1 Battery Life

The battery life of the MAT-1 logger depends on a range of factors of which the two most important are:

- Recording Intervals: The higher the logging frequency the shorter the battery life.
- Sensor Selection: Disabling sensors will extend battery life.

Table 1: Estimated Battery Life (Months) Under Various Scenarios for Continuous Use

Recording Frequency	Enabled Sensors			
	Magnetometer AND Accelerometer AND Temperature	Magnetometer AND Accelerometer	Magnetometer OR Accelerometer	Temperature Only
64 Hz	1.5	1.6	2.4	NA
32 Hz	2.3	2.6	4.2	NA
16 Hz	3.6	4.5	7.1	NA
8 Hz	5.3	7.3	11	NA
4 Hz	7.0	11	14	NA
2 Hz	8.3	14	17	NA
1 Hz	9.0	17	19	19
0.5 Hz	23	36	36	36
0.2 Hz	36	36	36	36

Other factors that impact battery life are:

- *Speed and power consumption of the microSD card:* There is a considerable amount of variability in the energy consumed by various cards and it is not obvious which cards will be best. For example, faster and more expensive cards are not always better. Check with Lowell Instruments if you plan on using an alternate card for a critical deployment.
- *Storage & operating temperature:* High temperatures will increase the self-discharge rate of the battery. Keep the logger below 25 °C when not in use. Cold temperatures, -10 °C and below, will reduce run time significantly.
- *Enabling the LED:* The LED blinks with each temperature measurement. Turning off the LED will extend deployments that have the temperature channel enabled by 5 to 10%.
- *Duty Cycle:* By using the Burst Interval, the duty cycle of the logger can be reduced. This will extend the battery life nearly proportionally to the duty cycle. Contact us if you have questions.

9.4.2 Safe Shutdown

The logger monitors the battery voltage and determines when the battery is nearly discharged. If the logger detects that the battery is near the end of its life, it attempts to execute a “Safe Shutdown.”

During a “Safe Shutdown” the logger will stop logging and enter sleep mode to save power. Up to 32K bytes of data may be lost during a safe shutdown, but by stopping logging before the battery is completely exhausted, there is a reduced chance of corrupted data from a brown-out. If a logger executes a “Safe Shutdown,” it will display “Stopped - Replace Battery” in the Logger Status Screen.

In the event of a sudden and total power loss, the logger will reset, up to 32KB of data may be lost and no additional data will be collected. The logger's clock will start counting up from 2000-01-01 00:00:00 when power is reapplied. See Trouble-Shooting for more information.

9.4.3 Replacing the Battery & Desiccant

To replace the battery, we recommend purchasing the appropriate tool kit:

- Battery Replacement Tool Kit for TCM-1, TCM-3, and MAT-1
- Battery Replacement Tool Kit for TCM-4

The logger contains two desiccant packages that are stored inside the housing between the battery and the locking plug.

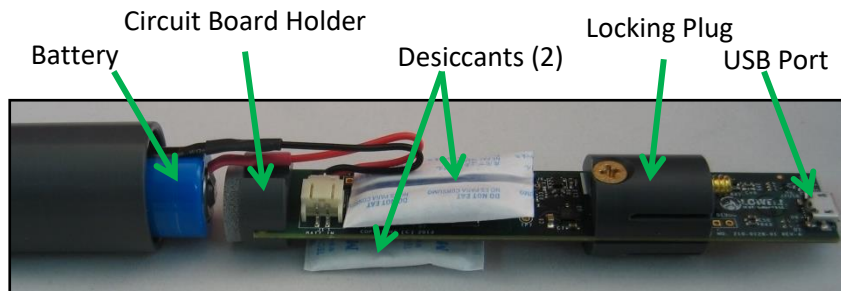

The battery and desiccant packs are user replaceable but require disassembling the logger; therefore, it is not recommended that they be replaced in the field. Detailed instructions, replacement batteries, desiccant, and tool kits are available from Lowell Instruments.

It is recommended that you replace the battery:

- Before critical deployments where the prior deployment history of the logger is unknown.
- For long-term deployments where battery life is potentially a limiting factor (see table above).
- If the status screen ever reports the battery status as “Bad.”
- If the battery voltage in the status screen falls below 3.4 volts.



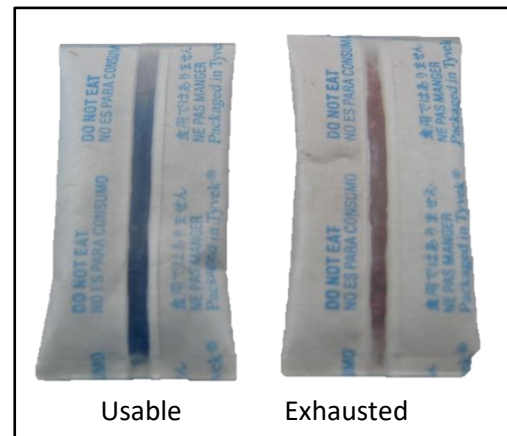

You should change the desiccant in the following circumstances:

- Any time the battery is replaced.
- If water enters the housing.
- For PVC housings if logger has been used in hot and wet or hot hand humid (>30 C) environments for more than 1 month.
- If the logger has been stored with the cap removed.
- Desiccant should be replaced if it is any color other than bright blue. Desiccant is bright blue when fresh, light blue when used and pink when exhausted.

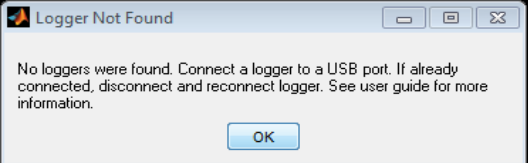
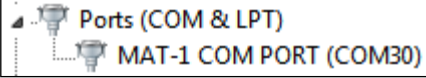

10 Trouble-Shooting the Logger and Software

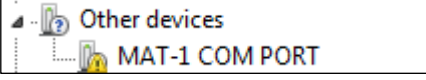
Our goal is that you will not ever have any problems with a Lowell Instruments data logger, but if an issue does come up, the list below is a good place to start. Visit www.lowellinstruments.com/Support for the most up to date information.

Problem	Possible Solutions
COM port changes numbers between uses.	<ul style="list-style-type: none"> Windows creates a new COM port for each physical USB port. Use the same USB port to maintain the same COM port.
<p>Logger Not Found error appears after clicking “Find Logger” in the Logger Status tab.</p> 	<ul style="list-style-type: none"> Double-check that the micro-B connector is fully inserted into the logger’s USB port. Disconnect and reconnect the USB cable and try again. Open Control Panel->Hardware and Sound-> Device Manager and look for Ports (COM & LPT). Verify that the COM port was installed: <div style="display: flex; justify-content: space-around; align-items: center;"> <div style="border: 1px solid black; padding: 5px; text-align: center;">  </div> <div style="text-align: center;">  Correct </div> </div> <div style="display: flex; justify-content: space-around; align-items: center; margin-top: 10px;"> <div style="border: 1px solid black; padding: 5px; text-align: center;">  </div> <div style="text-align: center;">  Error </div> </div> <p>If it is not installed check for the latest driver software at www.lowellinstruments.com/support.</p> <ul style="list-style-type: none"> Restart MAT Logger Commander. Restart your computer.
The MAT_LOGGER drive is not visible when the logger is connected to Windows.	<ul style="list-style-type: none"> Check that the logger is not running. The removable drive functionality is disabled when the MAT-1 is logging data. Open <i>MAT Logger Commander</i> and stop the logger. Disconnect and reconnect USB cable from the logger. Restart Windows. Eject the card and use a card reader to check that card is not damaged or corrupt.
Windows reports that the MAT_LOGGER drive is damaged and needs to be repaired.	<ul style="list-style-type: none"> This is a Windows error that occasionally occurs when the drive has been accessed by a third party application and the logger is started. Windows is typically not successful at repairing the drive. Cancel the dialog, open the card and save your data to your local drive and reformat the card. The drive should work normally after it has been reformatted.
Windows reports that media drive is corrupt and must be reformatted.	<ul style="list-style-type: none"> DO NOT REFORMAT the drive! Any data will be irretrievably lost. This error is usually a Windows error. Disconnect and reconnect the logger, and let it re-enumerate as a drive. Eject the card and read it with a card reader.

Problem	Possible Solutions
Desiccant is pink.	<ul style="list-style-type: none"> • Check the O-ring and O-ring sealing surfaces for nicks, cracks, or scratches. Replace the O-ring if suspect. Replace the desiccant. • PVC will absorb moisture when subjected to warm and wet conditions. Limit exposure to wet/humid environments above 30 °C or upgrade to an aluminum housing.
Logger time zone in the data file is incorrect.	<ul style="list-style-type: none"> • The logger does not “know” about time zones or Daylight Savings Time. It will count up from the time set by the host computer. If UTC time is desired, the PC should be set to UTC time before the logger’s clock is set.
Logger will not start logging.	<p>Check that:</p> <ul style="list-style-type: none"> • The SD card is installed in the logger. • The SD card contains a MAT.cfg file. • The “Stop Time” in the MAT.cfg file is in the future. • The SD card is non-corrupt. Remove the card from the logger and use a card reader to verify that Windows recognizes the card.
Logger stopped unexpectedly and clock is reset.	<ul style="list-style-type: none"> • The battery may be failing. Replace the battery if the logger’s use history is in doubt. • Moisture may have entered the case. Open the case and inspect/replace the desiccant. • The logger may have been shocked by a large electrostatic discharge (ESD) event and reset. Reset the time and ground yourself before connecting the USB cable to the logger. • A damaged card SD card can cause a fatal error. Check the card by inserting it into a card reader and verify that files can be read and written to the card.
Logger started or stopped unexpectedly, no errors.	<ul style="list-style-type: none"> • Check that the logger’s time and date were set to current time. Reset the clock if necessary. • Contact Lowell Instruments for support.
Red LED is blinking or continuously on.	<ul style="list-style-type: none"> • Open the “Logger Status” tab and connect to the logger. Check the status screen. There are several possible errors: <ul style="list-style-type: none"> ○ SD Card was removed while logging. ○ Critically low battery. Check logger status with <i>MAT Logger Commander</i>. ○ Other SD card failure likely from a defective card. • Contact Lowell Instruments for support.
Magnetometer values have an offset.	<ul style="list-style-type: none"> • The logger is sensitive to strong magnetic fields. It is possible that a strong magnetic field induced a semi-permanent offset in the magnetometer. Factory recalibration may be required.

10.1 Firmware Updates

The embedded software (firmware) that runs within the MAT-1 logger is upgradable via the USB cable. Lowell Instruments will periodically upgrade the firmware as new features are implemented or performance is improved. Check www.lowellinstruments.com/firmwareupdates for the latest information about firmware updates.

10.2 Serial Number

Each logger has a date & serial number laser-etched on the side of the case. The serial number includes a date code in the first four digits with the format YYMM. For example, the code 1501123 is decoded as:

Year	Month	Number
18	08	123

10.3 Repair Policy

Products that fail after the warranty period or that are damaged by the customer as specified in the warranty provisions can be returned to Lowell Instruments. See www.lowellinstruments.com/warranty for the warranty statement. Please contact us prior to returning your product(s).

10.4 Returning Products to Lowell Instruments

Please contact Lowell Instruments before returning your hardware. Ship the product(s) (properly packaged to protect against damage) to Lowell Instruments (at your expense) with your contact information, a brief description of the problem and your return shipping address. Lowell Instruments is not responsible for the loss of the package by any shipping company. Loggers must be clean and free of any hazardous substances before returned.

10.4.1 Return Shipping Address

Lowell Instruments, LLC
Attn: Returns
82 Technology Park Drive
East Falmouth, MA 02536
USA
Ph: 508-444-2616

11 Additional Information

11.1 Optional Accessories

Lowell Instruments offers a range of accessories such as:

- Spare O-rings and O-ring lubricant
- Battery replacement tool kits.
- Replacement batteries
- Replacement desiccant
- Miscellaneous spare parts

Please visit www.lowellinstruments.com/products for more information.

11.2 Contact Information

Please consult www.lowellinstruments.com for the most up-to-date documentation including specifications, software, manuals, FAQs, firmware updates, and application notes. You may contact us at support@lowellinstruments.com or (US) 508-444-2616.

Our mailing address is:

Lowell Instruments, LLC
33 Cameron Rd.
North Falmouth, MA 02556
USA

Mailing Address	Physical Address
Lowell Instruments, LLC 33 Cameron Rd. North Falmouth, MA 02556 USA	Lowell Instruments, LLC 82 Technology Park Dr. East Falmouth, MA 02536 USA

11.3 Disclaimer

Lowell Instruments has made a good faith effort to make sure that the information in this user guide is accurate and complete. However, we are not perfect and this guide may contain errors. We also reserve the right to change the specifications and instructions at any time and without notice.